

# Instruction Manual

## ETX® Premier Edition Telescope Series

AutoStar® — LNT™ — SmartFinder™







## WARNING!

**Never use a Meade® ETX® PE Telescope to look at the Sun!** Looking at or near the Sun will cause instant and irreversible damage to your eye. Eye damage is often painless, so there is no warning to the observer that damage has occurred until it is too late. Do not point the telescope at or near the Sun. Do not look through the telescope as it is moving. Children should always have adult supervision while observing.

**Caution:** Use care to install batteries in the orientation indicated by illustration in the battery slots of the battery compartment. Follow battery manufacturer's precautions. Do not install batteries backwards or mix new and used batteries. Do not mix battery types. If these precautions are not followed, batteries may explode, catch fire or leak. Improperly installed batteries void your Meade warranty.

**If you are anxious to use your telescope for the first time, read the QUICK-START GUIDE on pages 4 and 5.**

© The name "Meade," "ETX," "AutoStar" and the Meade logo are trademarks registered with the U.S. Patent Office and in principal countries throughout the world.

"LNT [Level North Technology]," "SmartFinder," "Deep Sky Imager," "LPI," and "Tonight's Best" are trademarks of Meade Instruments Corporation.

Patents:  
 US 6,304,376  
 US 6,392,799  
 US 6,563,636  
 D 422,610  
 Patent Pending

© 2004 Meade Instruments Corporation.

# CONTENTS

Quick-Start Guide .....	4
Telescope Features .....	6
AutoStar Features .....	9
Getting Started .....	12
Parts Listing .....	12
How to Assemble Your Telescope & Tripod .....	12
Using SmartFinder, Aligning SmartFinder .....	13
Choosing an Eyepiece .....	14
Observing .....	15
Observing by Moving the Telescope Manually.....	15
Terrestrial Observing .....	15
Observing Using AutoStar's Arrow Keys .....	15
Slew Speeds .....	16
Astronomical Observing, Observe the Moon.....	16
To Track an Object Automatically .....	16
Moving Through AutoStar's Menus.....	16
Initializing AutoStar for the First Time.....	17
Automatic Alignment.....	17
Observe a Star Using Automatic Tracking .....	18
Go To Saturn, Using the Guided Tour .....	19
Basic AutoStar Operation .....	20
AutoStar Navigation Exercise .....	20
Entering Data, Moving Through AutoStar's Menus ..	21
AutoStar Menus .....	22
Menu Tree .....	22
Objects Menu.....	23
Event Menu, Glossary Menu .....	24
Utilities Menu .....	25
Setup Menu .....	26
Advanced AutoStar Operation.....	29
Adding Observing Sites .....	29
Finding Objects Not in the Database.....	30
Observing Satellites.....	30
Create Your Own Guided Tour .....	31
Landmarks .....	34
Identify .....	35
Advanced Alt/Az Alignment Methods.....	36
Smart Drive Training (PEC) .....	37
Browse .....	38
Photography .....	39
Photography with AutoStar Suite .....	41
Optional Accessories.....	42
Maintenance .....	44
Troubleshooting .....	45
Specifications .....	47
Appendix A: Equatorial (Polar) Alignment .....	50
Equatorial Alignment, Celestial Coordinates .....	50
Polar Mounting with #884 Deluxe Field Tripod.....	50
Equatorial Mounting Procedure .....	51
To Track a Star When Polar Mounted.....	51
Polar Alignment Modes, Locating Celestial Pole .....	52
Setting Circles .....	53
Appendix B: Latitude Chart .....	54
Appendix C: Training the Drive .....	55
Appendix D: Changing the LNT Module Battery .....	56
Appendix E: Basic Astronomy .....	57

# QUICK-START GUIDE

This Quick Start Guide demonstrates how to install the batteries and eyepiece, and how to observe using the AutoStar Arrow keys. If you wish to try out AutoStar's "Go To" capabilities, check out the list of page references at the bottom of the following page.

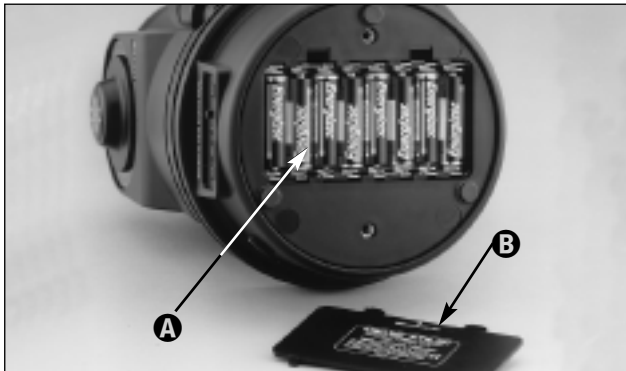

Remove the ETX® telescope from its packaging and place it on a sturdy surface. Place the ETX on its side and remove the battery compartment cover (A) from the underside of the drive base. Insert eight (user-supplied) AA-size batteries (B) oriented as shown in the battery compartment. Replace the cover and return the telescope to an upright position (if you wish to attach the telescope to the deluxe field tripod, see page 12).



Place the 26mm eyepiece (C) into the eyepiece holder on the telescope and tighten the attachment thumbscrew (D) to a "firm feel" only. See page 7, for more information. Remove the dust cover (E) from the end of the telescope tube.



Make sure that the computer control panel power switch (F) is in the OFF position. Remove the Autostar® handbox and the coiled cord from the packing materials. Plug one end of the cord into the HBX port (G).

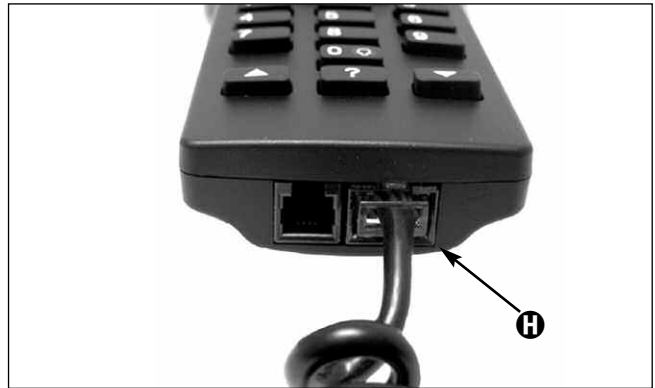

...and the other end of the coiled cord into the coiled cord port at the bottom of AutoStar handbox (H), as shown above.

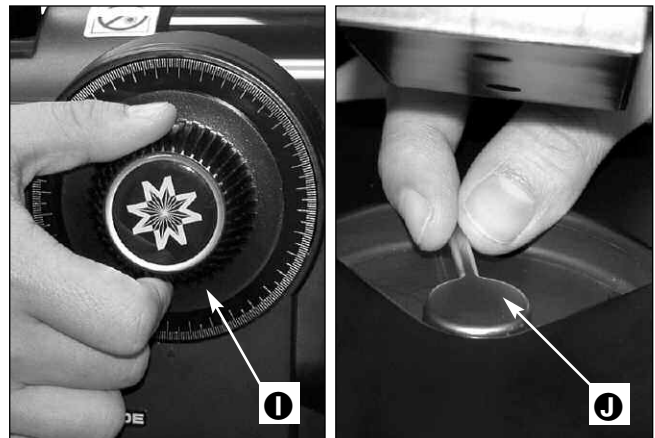

Tighten (to a "firm feel" only, do not overtighten) the vertical lock (I) and the horizontal lock (J). See page 7 and 8 for more information.



Flip the Power Switch (F) on the computer control panel to the ON position. A copyright message lights on AutoStar's LCD display, followed by a warning not to look at the Sun. Press the AutoStar key prompted by the message when you are done reading.

A "Getting Started" message displays. Press ENTER to skip this message.

See pages 9 to 11 for more information about AutoStar's keys.

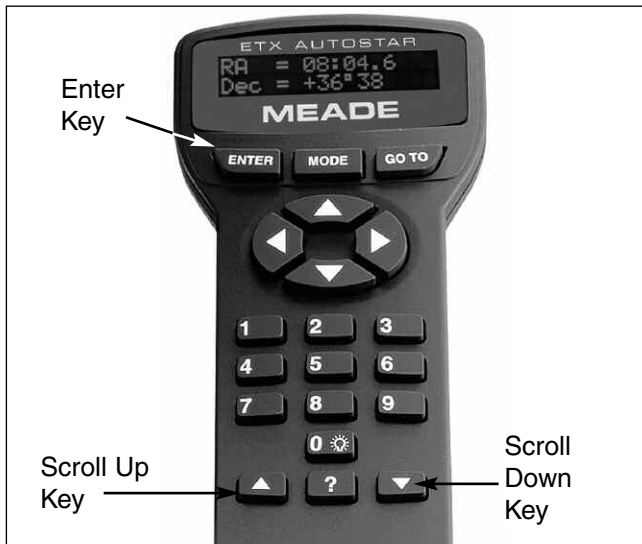

AutoStar then displays: "Location Option: 1-Zipcode 2-City". This option allows you to choose how you wish to enter the location of your observing site: you can enter your zip code or choose the site from a list of countries, states and cities.

Press the number key "1" if you wish to enter by zip code. Then enter the five digits of the zip code of your observing site and press ENTER.

Press the number key "2" if you wish to select your observing site from a list of country, states and cities. First, use a Scroll key to cycle through the list of countries and states (listed alphabetically). Press ENTER when the correct location displays. Next, use a Scroll key to cycle through the list of cities (also listed alphabetically). Press ENTER when the closest city displays.

Finally "Telescope Models" displays. Using the SCROLL KEYS, cycle through the list of telescope models and press ENTER when your model displays.

The display now displays "Setup: Align." See page 17 for more information.

*If AutoStar does not request the Country/State, City and Telescope Model information, use the "Telescope Model" and "Site" options in the Setup menu to change this information. See pages 27 and 29 for more information.*



You can now use the Arrow keys to slew (move) the telescope up, down, right or left. Practice using the ARROW KEYS to center objects in the eyepiece.

To change the speed at which the telescope moves (known as the "slew" speed) press a NUMBER KEY from 1 through 9. 1 is the slowest speed and 9 is the fastest.

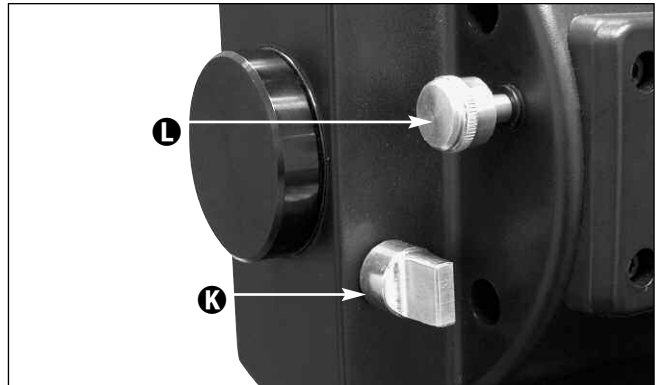

Make sure that the flip mirror control (K) is in the "Up" position, as shown the diagram above.

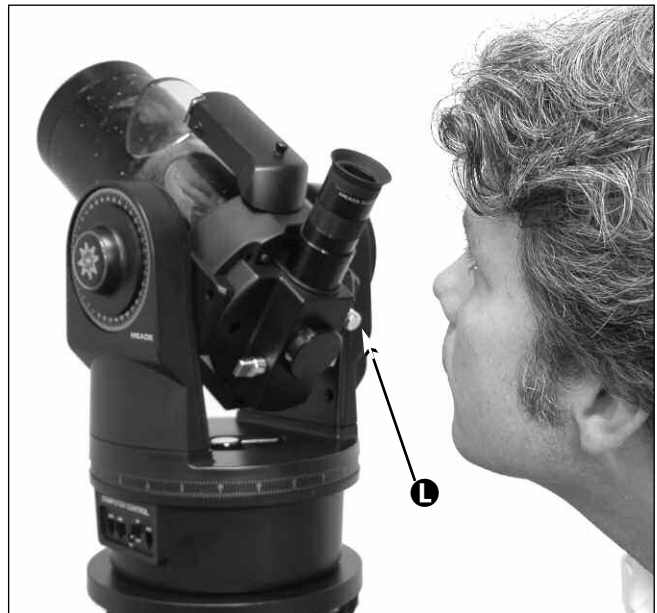

Sight along the side of the telescope's main tube to locate an object. If you wish to learn how to align the telescope's SmartFinder, see page 13.

Use the telescope's focus knob (L) to bring the object into focus.

**If you wish to learn more about observing with AutoStar and other features of your telescope, see:**

- Page 13 to learn how to use SmartFinder
- Page 17 to learn how to perform an Automatic Alignment
- Page 19 to learn how to "Go To" Saturn
- Page 19 to learn about Guided Tours
- Page 22 for a Menu tree of AutoStar's menus
- Pages 23 to 38 to learn more about AutoStar's menus

# TELESCOPE FEATURES

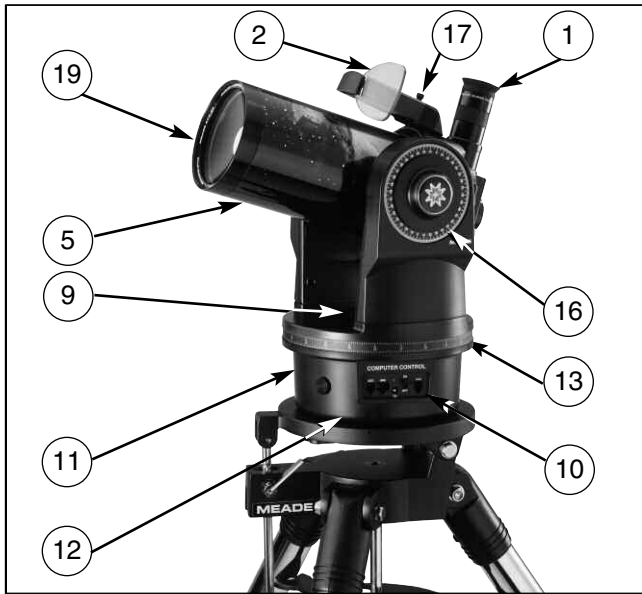

Fig. 1a: Side View

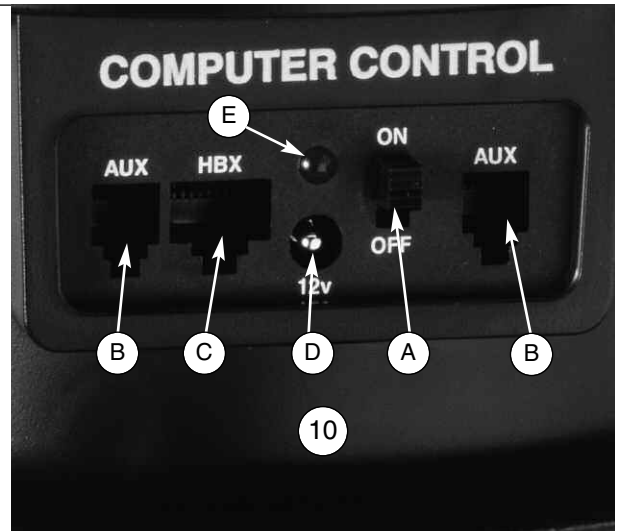

Fig. 2 (Inset): Computer Control Panel. (A) On/Off switch; (B) Auxiliary ports; (C) Handbox port; (D) 12v connector; (E) Power indicator light.

Features of the ETX-90PE, ETX-105PE and ETX-125PE are identical, with the exception of the size of optical tube.

Fig. 1a, b and Fig. 2:  
The ETX Premier Telescope

- 1 Eyepiece
- 2 SmartFinder
- 3 Holder Thumbscrew
- 4 90° Eyepiece Holder
- 5 Optical Tube
- 6 Vertical (Dec.) Lock
- 7 Fork Arms
- 8 Focus Knob
- 9 Horizontal (R.A.) Lock
- 10 Computer Control Panel
  - A. ON/OFF Switch
  - B. Auxiliary Ports (2)
  - C. Handbox Port
  - D. 12v
  - E. LED
- 11 Base Housing
- 12 Battery Compartment (bottom of base)
- 13 Right Ascension (R.A.)/Horizontal Setting Circle
- 14 Flip-Mirror Control Knobs
- 15 Photo Port
- 16 Declination (Dec.)/Vertical Setting Circle
- 17 SmartFinder Alignment Screws
- 18 LNT Module
- 19 Dust Cap (not visible)

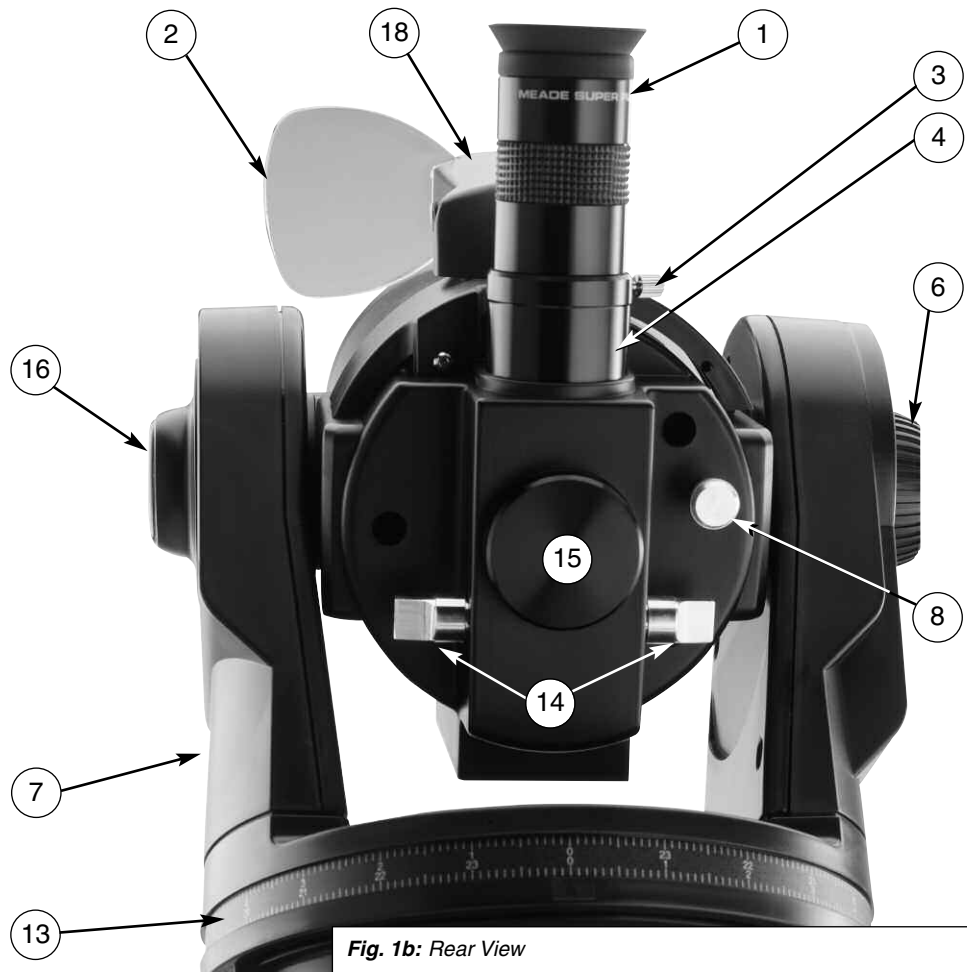

Fig. 1b: Rear View

# MEADE ETX: YOUR PERSONAL WINDOW TO THE UNIVERSE

## Caution:

Using products other than standard Meade accessories may cause damage to the telescope's internal electronics and may void the Meade warranty.

1 Want to learn more about the **eyepieces** available for your ETX telescope?

See **OPTIONAL ACCESSORIES**, pages 42 and 43.

2 Want to learn more about the **SmartFinder**?

See **Aligning SmartFinder**, page 13.

6 Want to learn more about the **Right Ascension and Declination setting circles**? See page 54.

## Caution:

When loosening the Dec. lock, be sure to support the optical tube (5 Fig. 1a). The weight of the tube could cause the tube to swing through the fork arms suddenly.

The Meade Premier Edition ETX-90PE, ETX-105PE and the ETX-125PE are extremely versatile, high-resolution telescopes. With pushbutton controls, automatic tracking of celestial objects and diffraction-limited imaging, an ETX Premier telescope may be all the telescope ever required by many terrestrial and astronomical observers.

Your ETX telescope reveals nature in an ever-expanding level of detail. Observe the feather structure of an eagle from 50 yards or study the rings of the planet Saturn from a distance of 800 million miles. Focus beyond the Solar System and observe majestic nebulae, ancient star clusters, remote galaxies and even stars recently discovered to have planets orbiting about them. Meade ETX Premier telescopes are instruments fully capable of growing with your interest and are ideal for both the casual observer and serious astronomer alike.

## Telescope Controls

Become acquainted with all of these controls before attempting observations through the telescope.

- 1 **Eyepiece:** Place the supplied 26mm eyepiece into the 90° Eyepiece Holder (4, Fig. 1b) and tighten in place with thumbscrew (3, Fig. 1b).
- 2 **Smartfinder™**  
Provides an easier way to sight on objects than the main telescope's eyepiece which has a narrow field of view. Comes pre-assembled on the telescope.
- 3 **Eyepiece Holder Thumbscrew:** Tightens the eyepiece in place. Tighten to a firm feel only.
- 4 **90° Eyepiece Holder:** Holds the eyepiece upright for easy viewing.
- 5 **Optical Tube:** The main optical component that gathers the light from distant objects and brings this light to a focus for examination with the eyepiece.
- 6 **Vertical (Dec.) Lock:** Controls the manual vertical movement of the telescope. Turning the vertical lock counterclockwise unlocks the telescope enabling it to be freely rotated by hand about the vertical axis. Turning the vertical lock clockwise (to a firm feel only) prevents the telescope from being moved manually, but engages the vertical motor drive clutch for AutoStar operation. When polar aligned, the vertical lock serves as the Declination or Dec. lock.  
*Note: The vertical lock knob is a knurled knob located on the fork arm to the right of the focus knob (8, Fig. 1b). Mounted beneath the knob is a circular scale without numbers. Do not confuse this scale with the Dec. setting circle (16, Fig. 1a) on the opposite fork arm which has a numbered scale used to locate astronomical objects.*
- 7 **Fork Arms:** Hold the optical tube in place.  
*Note: The telescope base and fork mount are designed with internal "rotational limit stops." The horizontal limit stop prevents the telescope from rotating more than 630° to avoid damage to the internal wiring. The vertical limit stop prevents the smartfinder from striking the fork mount when the telescope is pointed upward just past 90° and prevents the optical tube from striking the base if pointed downward more than 30°. Do not force the telescope to move beyond these stops or damage to the telescope will result.*
- 8 **Focus Knob:** Moves the telescope's primary mirror in a finely-controlled motion to achieve precise image focus. The ETX telescopes can be focused on objects from a distance of about 11.5 ft (ETX-90PE) or 15 ft (ETX-105PE or ETX-125PE) to infinity. Rotate the focus knob clockwise to focus on distant objects and counterclockwise to focus on nearby objects.

### Definitions

Throughout this manual, you will notice the terms "Alt/Az," "Right Ascension," and "Declination." Alt/Az or more properly, altazimuth, is frequently used to refer to altitude or Declination (the up-and-down vertical movement of the telescope) and azimuth or Right Ascension (the side-to-side horizontal movement of the telescope). Right Ascension is abbreviated as "R.A." and Declination as "Dec."



Fig. 3a: Flip mirror control in the "up" position.

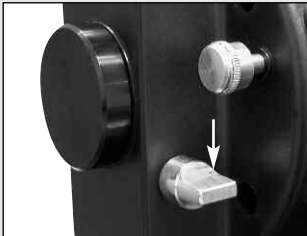

Fig. 3b: Flip mirror control in the "down" position.

- 18 Want to learn more about aligning the SmartFinder?  
See pages 13.

- 19 **Note:** The dust cap should be replaced after each observing session and the power turned off to the telescope. Verify that any dew that might have collected during the observing session has evaporated prior to replacing the dust cap. Do not overtighten.

- 9 **Horizontal (R.A.) Lock:** Controls the manual horizontal rotation of the telescope. Loosen the horizontal lock counterclockwise to unlock the telescope, enabling it to be freely rotated by hand about the horizontal axis. Tightening the horizontal lock clockwise prevents the telescope from being rotated manually, but engages the horizontal motor drive clutch for AutoStar operation. When polar aligned, the horizontal lock serves as the Right Ascension or R.A. lock.
- 10 **Computer Control Panel (see Fig. 2)**
- A. **ON/OFF Switch:** Turns the Computer Control Panel and AutoStar handbox ON or OFF.  
**Note:** Always remove the batteries if they are not to be used for a long period of time.
  - B. **Auxiliary (AUX) Ports (2):** Provide connection for current and future Meade accessories. See **OPTIONAL ACCESSORIES**, page 42.
  - C. **Handbox (HBX) Port:** Plug the AutoStar handbox into this port.
  - D. **12v:** The 12v connector is designed to accept an external power supply such as the optional #541 AC Adapter or the #607 Power Cord (see **OPTIONAL ACCESSORIES**, page 42). When one of the external power supply options is used, the internal batteries are disconnected from the power circuit.
  - E. **LED:** The red power indicator light illuminates when power is supplied to the connected handbox and to the telescope's motor drive.
- 11 **Base Housing:** Supports the telescope for placement on a flat, level surface, such as a tabletop or tripod.
- 12 **Battery Compartment (not shown, underneath base):** Install eight user-supplied AA batteries in this compartment. See page 12 for more information.
- 13 **Right Ascension (R.A.) Setting Circle:** See page 53 for detailed information.
- 14 **Flip-Mirror and Flip-Mirror Control Knobs:** ETX telescopes include an internal mirror. With the flip-mirror control in the "up" position, as shown in **Fig. 3a**, light is diverted to the eyepiece. With the flip-mirror control in the "down" position, as shown in **Fig. 3b**, light proceeds straight out the photo port for photography. See **PHOTOGRAPHY**, page 39.  
**Note:** The flip-mirror control is in the "up" position when the control is vertical (perpendicular to the telescope tube). To place the flip-mirror in the "down" position, turn the control until it is horizontal.
- 15 **Photo Port:** Attach any 35mm camera with a removable lens to this port using an optional #64ST T-Adapter or attach the #932 Erecting Prism for correctly oriented images through the eyepiece. See **OPTIONAL ACCESSORIES**, page 42.
- 16 **Declination (Dec.) Setting Circle** (on left fork arm): See page 53 for detailed information.
- 17 **SmartFinder Alignment Screws:** Adjust these screws to align the SmartFinder. See pages 13 and 14 for more information.
- 18 **LNT (Level North Technology) Module:** This assembly has sensors which automatically points the telescope North, and detects the level and tilt of the telescope during automatic alignment. See page 17 for more information about Automatic Alignment. The LNT bracket also contains a LNT Module which supplies the time and date to AutoStar. The time is set at the factory. See **ATOMIC TIME UPDATE MODULE PORT** below.
- 19 **ATOMIC TIME UPDATE MODULE Port:** Attach Meade's **ATOMIC TIME UPDATE MODULE** optional accessory into this port. Your telescope's time is set at the factory before it is shipped, but the **ATOMIC TIME UPDATE MODULE** allows your telescope to update the time module from the NIST atomic clock in Fort Collins, Colorado.
- 20 **Dust Cap:** Unthread the dust cap counterclockwise from the front lens of the telescope.



# AUTOSTAR FEATURES

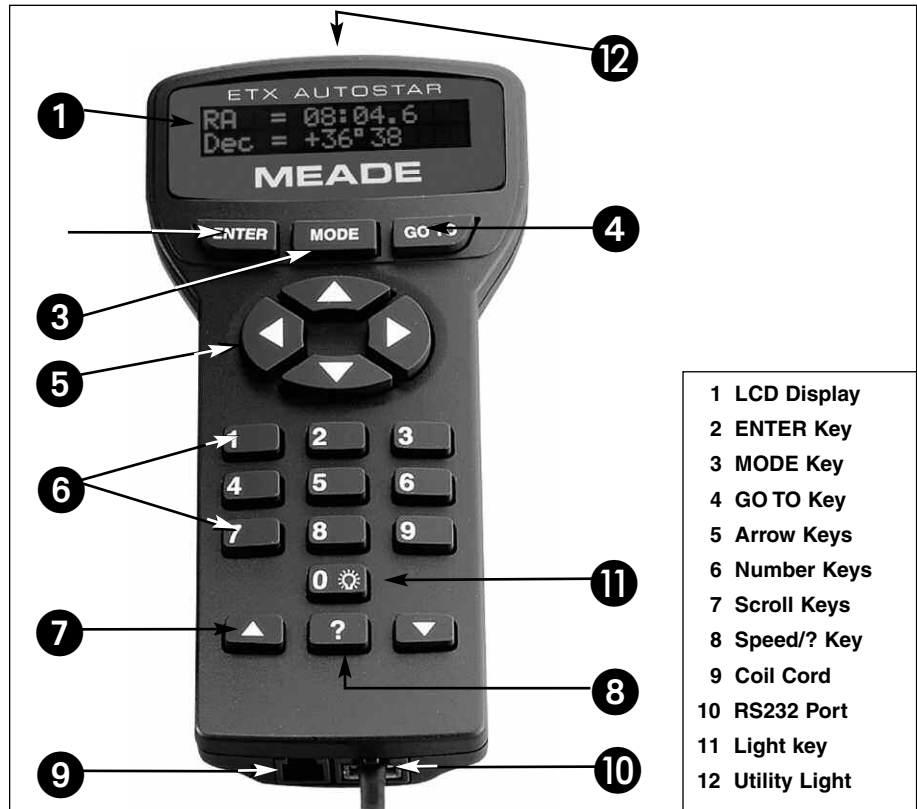

Fig. 4: The AutoStar Handbox.

## Tour the Cosmos with Just the Push of a Button

Control of ETX Telescopes is through the operation of the standard-equipment #497 AutoStar. Nearly all functions of the telescope are accomplished with just a few pushes of AutoStar's buttons. Some of the major features of AutoStar are:

- Automatically move the telescope to any of the 30,000 objects stored in the database or manually enter the astronomical coordinates of any celestial object.
- Take a guided tour of the best celestial objects to view on any given night of the year.
- Download the latest satellite data, guided tours and software revisions directly from the Meade website ([www.meade.com](http://www.meade.com)) and share software with other AutoStar enthusiasts. (Requires optional #505 AstroFinder™ Cable Connector Kit. See **OPTIONAL ACCESSORIES**, page 42.)
- Access a glossary of astronomical terms.
- Calculate which eyepiece to use for optimum viewing of a celestial object.

AutoStar provides control of virtually every telescope function. The AutoStar handbox has soft-touch keys designed to have a positive feel. The LCD (Liquid Crystal Display) is backlit with red LEDs (Light Emitting Diodes) for easy viewing in the dark. The backlit display, key arrangement and sequential menu structure make AutoStar extremely user friendly.

Want to learn more about downloading the latest updates of AutoStar software from the Meade website? See pages 28 and 42.

❶ **2-Line LCD Display:** This screen displays AutoStar's menus and information about the telescope.

- **Top line:** Lists the primary menu.
- **Bottom line:** Displays other menus that may be chosen, menu options, telescope status or information about a function that is being performed.

❷ **ENTER Key:** Press to go to the next menu level or to choose an option in a menu. The ENTER key is similar to the RETURN or ENTER key on a computer. See **MOVING THROUGH AUTOSTAR'S MENU**, page 21 and **AUTOSTAR MENU**, page 22.

❸ **MODE Key:** Press to return to the previous menu or data level. The top menu level is "Select Item." The MODE key is similar to the ESCAPE key on a computer.

*Note: Pressing MODE repeatedly while in the "Select Item" level moves AutoStar to the topmost screen: "Select Item: Object."*

If MODE is pressed and held for two seconds or more, information about the telescope's status displays. When the status displays, press one of the Scroll keys (7, Fig. 2) to display the following information:

- Right Ascension and Declination (astronomical) coordinates
- Altitude (vertical) and Azimuth (horizontal) coordinates
- Local Time and Local Sidereal Time (LST)
- Timer and Alarm Status
- Date
- Site coordinates
- Battery status
- SmartFinder Finder Set menu (see below)

Press MODE again to return to the previous menu.

**Finder Set menu:** Select the Finder Set menu to access options that will allow you to set the **intensity** and **blink rate** of the SmartFinder red dot.

**To set the blink rate of SmartFinder's red dot** (circled numbers refer to Fig. 4):

1. Press and hold MODE ❷ for two seconds. R.A and Dec. coordinates display.
2. Keep pressing the Scroll Down key ❷ until "Finder Set: Set" displays.
3. Press ENTER ❶. "Finder Set: Intensity" displays.
4. Press the Scroll Down key ❷. "Finder: Blink On" displays.
5. Press ENTER ❶. A time value, in seconds, displays. For example, "00.5" may display. "00.5" (one-half second) is the amount of time, in seconds, that the red dot will blink "on."
6. Use the Number keys ❹ and the Arrow keys ❺ to change the time value. For example, you may wish to change the amount of time the red dot stays on to 10.2 seconds: Press "1," press the Right Arrow key ❺, press "0," press the Right Arrow key ❺, press "2." An alternate method is to use the Scroll keys ❷ to scroll through the time values. Once the time value is entered, press ENTER ❶.
7. Press the Scroll Down key ❷. "Finder: Blink Off" displays. Press ENTER ❶. A time value, "00.1" (one-tenth second), may display. For example, you may wish to change the amount of time the red dot stays off to 00.7 seconds: Press the Right Arrow key ❺ twice (as the first two values are already zero), then press "7." Or you may use the Scroll keys ❷ to scroll through the time values.
8. The SmartFinder's red dot will now blink on for 10.2 seconds and turn off for 0.7 seconds, and then repeat the cycle until you change the values again. Press and hold MODE ❷ to exit this function.

Similarly, you can set the Intensity value by scrolling through the intensity values with then Scroll keys ❷. The option lets you select a value of intensity for the red dot from 0 (Off) to 14 (Full Intensity).

❹ **GO TO Key:** After the telescope is aligned, press to slew (move) the telescope to the coordinates of the currently selected object. While the telescope is slewing, the operation may be aborted at any time by pressing any key except GO TO. Pressing GO TO again resumes the slew to the object. Also, press during the alignment or GO TO procedures to activate a "spiral search."

❹ *Want to learn more about using the **GO TO function**? See page 19.*

*Want to learn how to perform a **spiral search**? See page 19.*

6 Want to learn more about **changing slew speeds**? See page 16.

Also, use the Arrow keys to scroll through numbers 0 through 9 and the alphabet. The Down Arrow key begins with the letter "A;" the Up Arrow key begins with digit "9."

Additionally, use the Arrow keys to move the cursor across the display: Use the Right or Left Arrow key to move the cursor from one number to the next in the display.

5 **Arrow Keys:** The Arrow keys have several functions. Press an Arrow key to slew the telescope in a specific direction (up, down, left and right), at any one of nine different speeds. See **SLEW SPEEDS**, page 16. Use the Arrow keys to move the telescope vertically up and down. The Left Arrow key rotates the telescope horizontally counterclockwise, while the Right Arrow key rotates it clockwise.

6 **Number Keys:** Press to input digits 0 to 9. To change the speed at which the telescope moves (known as the "slew" speed) press a NUMBER KEY from 1 through 9. 1 is the slowest speed and 9 is the fastest.

7 **Scroll Keys:** Press to access options within a selected menu. The menu is displayed on the first line of the screen. Options in the menu are displayed, one at a time, on the second line. Press the Scroll keys to move through the options. Press and hold a Scroll key to move quickly through the options.

The Scroll keys also control the speed of text scrolling on the AutoStar display. When text is scrolling, press and hold the Up Scroll key for a faster display speed and the Down Scroll key for a slower display speed.

8 **? Key:** Press to access the "Help" file. "Help" provides on-screen information on how to accomplish whatever task is currently active.

Press the ? key and then follow the prompts on the display to access details of AutoStar functions in the Help feature. The Help system is essentially an on-screen instruction manual.

If you have a question about an AutoStar operation, *e.g.*, **INITIALIZATION, ALIGNMENT, etc.**, press the ? key and follow the directions that scroll on the second line. When satisfied with the Help provided, press MODE to return to the original screen and continue with the chosen procedure.

9 **RS232 Port:** Plug in optional cable to download the latest satellite data and software revisions directly from the Meade website ([www.meade.com](http://www.meade.com)). You can also share software with other AutoStar enthusiasts or control your telescope remotely from your PC. (Requires optional #505 AstroFinder™ Software and Cable Connector Kit. See **OPTIONAL ACCESSORIES**, page 42.)

10 **Coil Cord Port/Coil Cord:** Plug one end of the supplied AutoStar coil cord into this port located at the bottom of the handbox and the other end into the HBX port of the Computer Control Panel.

11 **Light/0 Key:** Press to turn on Utility light (12, Fig. 4).

12 **Utility Light:** Use this built-in red light to illuminate star charts and accessories without disturbing your eye's adaptation to darkness. Press "0" to turn the light on and off.

## ETX TIPS

### Star Charts

Even with the AutoStar's large 30,000 object library, star charts and planispheres are still useful for a variety of reasons. In particular, they are a great aid in planning a night of celestial viewing.

A wide variety of star charts are available in books, in magazines, on the internet and on CD Roms. Meade offers AutoStar Suite™ and other star locator software. Contact your Meade dealer or Meade's Customer Service department for more information.

*Astronomy and Sky and Telescope* magazines print star charts each month for up-to-the-minute maps of the heavens.

# GETTING STARTED

## Parts Listing

Getting the telescope ready for first observations requires only a few minutes. When first opening the packing box, note carefully the following parts:

- ETX Premier Telescope with fork mount system and SmartFinder
- #497 AutoStar handbox with coil cord.
- One or more eyepieces, packed in plastic storage containers.
- Hex-wrench, packed with the instruction manual. See **MAINTENANCE**, page 44.
- #884 Deluxe Field Tripod; two attachment knobs; spreader tray with separate spring, washers (2) and tension knob; leg extension lock knobs.

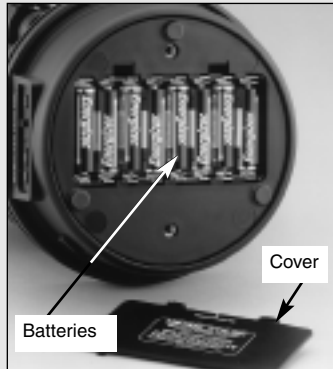

Fig. 5: Battery installation.



Fig. 6: Spread tripod legs.

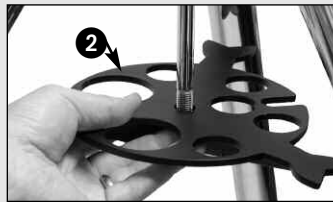

Fig. 7: Slide spreader on rod.



Fig. 8: Tension knob assembly.



Fig. 9: Adjust tripod height.

## How to Assemble Your Telescope and Tripod

Assembly of the ETX telescope requires eight AA-size (user-supplied) batteries.

1. Remove the ETX telescope from its packaging and place it on a sturdy surface. Place the ETX on its side and remove the battery compartment cover from the underside of the drive base. Insert eight (user-supplied) AA-size batteries into the battery compartment oriented as shown in the battery compartment. Replace the cover and return the telescope to an upright position.

**Caution:** Use care to install batteries as indicated by the diagrams in the battery compartment. Follow battery manufacturer's precautions. Do not install batteries backwards or mix new and used batteries. Do not mix battery types. If these precautions are not followed, batteries may explode, catch fire or leak. Improperly installed batteries void your Meade warranty. Always remove the batteries if they are not to be used for a long period of time.

**Note:** AutoStar does not require batteries; the telescope's batteries supply power to AutoStar.

2. Assemble the #884 Deluxe Field Tripod:

**Step a:** Spread the tripod (1, Fig. 6) legs apart to a fully open position.

**Step b:** Slide the spreader tray (2, Fig. 7) onto the central threaded rod.

**Step c:** Slide a washer, followed by the spring, another washer and the tension knob (3, Fig. 8) onto the threaded rod. Tighten the tension knob to a firm feel.

**Step d:** Adjust the height of the tripod by loosening the leg lock knobs (4, Fig. 9) and adjusting the height of the inner leg extensions. Then retighten the lock knobs.

3. Mount your telescope in the altazimuth (alt/az) mode. If you wish to mount your telescope in the equatorial mode, see **EQUATORIAL ALIGNMENT**, page 50.

**Note:** Throughout this manual, you will notice the term "**Alt/Az**," or more properly, **altazimuth**. This term is frequently used to refer to **altitude** or the up-and-down vertical movement of the telescope). **Azimuth** refers to the side-to-side horizontal movement of the telescope.

**Step e:** Loosen the latitude control latch (6, Fig. 10) and lift up the tilt-plate (5, Fig. 10) so that you can easily access the underside of the plate. Relock the latitude control latch, so the assembly doesn't slip while you are attaching the telescope.

**Step f:** Line up the mounting hole (7, Fig. 11) on the base of the telescope marked "High Latitude Leg" with the attachment knob (8, Fig. 11) that is closest to the latitude control bar (9, Fig. 11). Line up the other mounting hole with the attachment knob at the bottom of the tilt-plate. Thread both attachment knobs into the base of the telescope. Tighten to a firm feel only. (See Fig. 12.)

**Step g:** Unlock the latitude control latch (10, Fig. 13) and lower the tilt-plate until it is level (push the tilt-plate down until it stops; this is the level position). Lock the latitude control latch.

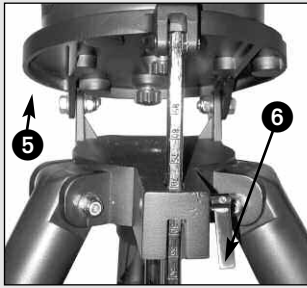

**Fig. 10:** Loosen control latch .

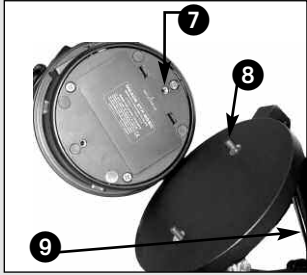

**Fig. 11:** High latitude leg mounting hole and corresponding attachment knob.



**Fig. 12:** Attach telescope to tripod.



**Fig. 13:** Level tilt-plate.



**Fig. 14:** Handbox HBX port.

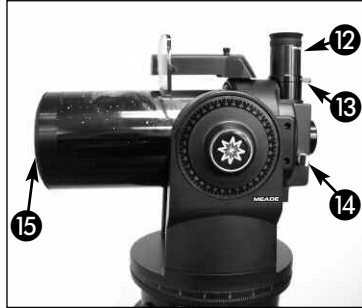

**Fig. 15:** Insert eyepiece.



**Fig. 16:** Tighten vertical lock.



**Fig. 17:** Tighten horizontal lock.

4. Place the 26mm eyepiece (12, Fig. 15) into the eyepiece holder on the telescope and tighten the attachment thumbscrew (13, Fig. 15) to a "firm feel" only. Make sure that the flip-mirror control (14, Fig. 15) is in the "up" position, as shown in the above photo. See page 14, for more information. Remove the dust cover (15, Fig. 15) from the end of the telescope tube.
5. Make sure that the computer control panel power switch (A, Fig. 2) is in the OFF position. Remove the AutoStar handbox and the coiled cord from the packing materials. Plug one end of the cord into the HBX port (C, Fig. 2) and the other end of the coiled cord into the coiled cord port at the bottom of AutoStar handbox, as shown above.
6. Tighten (to a "firm feel" only, do not overtighten) the vertical lock (Fig. 6) and the horizontal lock (Fig. 9).

## Using SmartFinder

As with most astronomical telescopes, an eyepieces presents a narrow field of view to the observer. As a result it is sometimes difficult to locate objects just using your eyepiece. The SmartFinder has a projected red dot that helps you to locate objects as you move your telescope.

### To turn on SmartFinder's red dot (continuous, without blinking):

1. Press and hold MODE for two seconds. R.A and Dec. coordinates display.
2. Keep pressing the Scroll Down key until "Finder Set: Set" displays.
3. Press ENTER. "Finder Set: Intensity" displays.
4. Press the Scroll Down key. "Finder: Blink On" displays.
5. Press ENTER. A time value, in seconds, displays. For example, "00.5" may display. "00.5" is the amount of time, in seconds, that the red dot will blink "on." (For this example, you may select or enter any value except "00.0.") Press ENTER.
6. Press the Scroll Down key. "Finder: Blink Off" displays.
7. Press ENTER. Use the Number keys to enter "00.0" or press the Scroll Down key until "00.0" displays. "00.0" is the amount of time in seconds that the red dot will remain "off." This value, along with the value you chose in the "Finder: Blink On" menu, allows the red dot to remain on without blinking. "00.0" means there is no "off" time, so the dot will remain on continuously, without blinking.
8. Use these menus to set other blink rates. For example, If you select "00.1" in the Blink Off menu, and "00.2" in the Blink On menu, the red dot will blink on for .2 seconds and then blink off for .1 second, and then repeat the cycle until you change the values again.
9. Press and hold MODE to exit this function.

## Aligning SmartFinder

In order for the SmartFinder to be useful, it must first be aligned with the main telescope, so that both the SmartFinder and the main telescope are pointing at precisely the same location. To align the SmartFinder:

1. Point the main telescope at some well-defined distant (perhaps a mile away) land object, such as a telephone pole or sign. Center the object, as precisely as

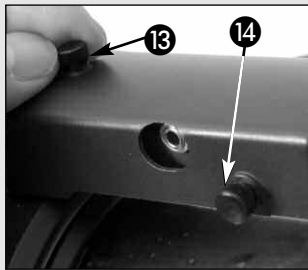
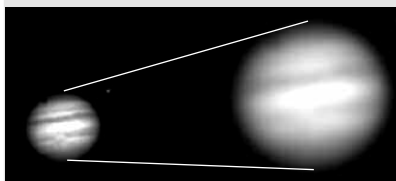

**Fig. 18:** Turn the top (13) or side (14) Smartfinder adjustment screws.



**Fig. 19:** Meade Super Plössl eyepieces.

**Tip:** If you plan on viewing using higher magnification eyepieces, first locate, center and focus the object using a low-power eyepiece (e.g., 26mm eyepiece). Then remove the low-power eyepiece and replace it with a higher-power eyepiece; the object should still be centered in the field of view. Objects are much easier to locate and center at lower powers; higher powers are employed simply by changing eyepieces.



**Fig. 20a & 20b:** Jupiter: Examples of the right amount of magnification and too much magnification.

possible, in the SP 26mm eyepiece's field of view. Tighten the vertical and horizontal locks (6 and 9, Fig. 1) so that the tube cannot move and the object remains centered.

2. While looking through the SmartFinder, turn the top or side alignment screws (13 and 14, Fig. 18), until the red dot of the SmartFinder points at precisely the same position as the view through the eyepiece of the main telescope.

The SmartFinder is now aligned to the main telescope. Unless the alignment screws are disturbed or the LNT Module is moved out of place, the SmartFinder should remain aligned indefinitely.

## Choosing an Eyepiece

The magnification or power, at which a telescope is operating is determined by two factors: the focal length of the telescope and the focal length of the eyepiece.

**Telescope Focal Length** is the distance that light travels inside the telescope before reaching a focus. In the mirror-lens design of the ETX models, the focal length is compressed by the telescope's secondary mirror, so that a long focal length is housed in the short ETX optical tube. For example, the ETX-90PE's focal length is 1250mm or about 49". This means that if the ETX-90PE were a classical refracting-type of telescope, the optical tube would be more than four feet long instead of the ETX-90PE's compact 11" tube length.

**Eyepiece Focal Length** is the distance light travels inside the eyepiece before reaching focus. Focal length is usually printed on the side of the eyepiece, for example, 26mm. Low-power eyepieces are typically available in 26mm, 32mm and 40mm sizes (see **OPTIONAL ACCESSORIES**, page 42). The low-power eyepiece provided with your ETX is designed to provide a wide, comfortable field of view with high image resolution.

**Calculating Magnification:** On a telescope, such as the ETX, different eyepiece focal lengths are used to achieve different magnifications, from low to high. A 26mm eyepiece yields 48X ("48-power") on the ETX-90PE, 57X on the ETX-105PE and 73X on the ETX-125PE. A variety of powers may be obtained with the addition of optional eyepieces as well as the #126 2X Barlow Lens which doubles the power of an eyepiece (see **OPTIONAL ACCESSORIES**, page 42). To calculate magnification, divide the focal length of the telescope's optical tube by the focal length of the eyepiece. For example:

Telescope Focal Length divided by Eyepiece Focal Length	= Power
1250mm divided by 26mm	= 73X
With Barlow: 73 x 2	= 146X

The eyepiece power or magnification is therefore 73X and 146X with the Barlow.

Most observers should have 3 or 4 eyepieces plus the #126 2X Barlow to achieve the full range of reasonable magnifications possible with ETX models.

## ETX TIPS

### Too Much Power?

Can you ever have too much power? If the type of power you're referring to is eyepiece magnification, yes, you can! The most common mistake of the beginning observer is to "overpower" a telescope by using high magnifications which the telescope and atmospheric conditions cannot reasonably support. Keep in mind that a smaller, but bright and well-resolved image is far superior to one that is larger, but dim and poorly resolved (see Figs. 20a and 20b). Powers above 300X should be employed only under the steadiest atmospheric conditions.

AutoStar can calculate the best eyepiece for you to use. Try out the "Eyepiece Calc" feature in the Utilities menu.

Most observers should have three or four additional eyepieces to achieve the full range of reasonable magnifications possible with the ETX telescopes. See **OPTIONAL ACCESSORIES**, page 42.

# OBSERVING

## Observing by Moving the Telescope Manually

If you wish to observe a distant land object, such as a mountain top or a bird, you can observe by merely pointing the telescope and looking through the eyepiece.

1. Loosen the telescope's horizontal lock (**9, Fig. 1a**) and vertical lock (**6, Fig. 1b**).
2. Move your telescope to observe distant street signs, mountains, trees and other structures. Use the SmartFinder to help sight-in on an object.
3. Center the object with SmartFinder's red dot and then in the telescope eyepiece. When the object is centered in your eyepiece, remember to re-tighten the horizontal and vertical locks.
4. Practice focusing objects using the focus knob (**8, Fig. 1b**).
5. Once you get a feel for how your telescope moves and focuses, try to view something more challenging, like a bird or a distant moving train.

You can also observe stars and objects in the night sky using this method, but note that objects begin to slowly drift across the eyepiece field. This motion is caused by the rotation of the Earth. As you become familiar with the AutoStar handbox operation, you can counteract the drift using the automatic tracking feature (see **TO TRACK AN OBJECT AUTOMATICALLY**, page 16) or by using AutoStar's GO TO capabilities (see **GO TO SATURN**, page 19).

## Terrestrial Observing

ETX telescopes are excellent high-resolution terrestrial (land) telescopes. Viewing terrestrial objects requires looking along the Earth's surface through heat waves. These heat waves often cause degradation of image quality. Lower power eyepieces, like the 26mm, magnify these heat waves less than higher power eyepieces (such as a 9mm eyepiece). Therefore, lower power eyepieces provide a steadier, higher quality image. If the image is fuzzy or ill-defined, reduce to a lower power eyepiece, where the heat waves do not have such an effect on image quality. Observing in early morning hours, before the ground has built up internal heat, produces better viewing conditions than during late afternoon hours.

## Observing Using AutoStar Arrow Keys

You may observe land and astronomical objects using AutoStar's Arrow keys to move the telescope.

1. Tighten the horizontal (**9, Fig. 1a**) and vertical locks (**6, Fig. 1b**).
2. Make sure that AutoStar's coiled cord is connected to the computer control panel's HBX port (**C, Fig. 2**).
3. Flip the Power Switch (**A, Fig. 2**) on the computer control panel to the ON position. A copyright message lights on AutoStar's LCD display, followed by a warning not to look at the Sun. Press the AutoStar key prompted by the message when you are done reading. See page 9 to 11 for more information about AutoStar's keys.
4. A "Getting Started" message displays. Press ENTER to skip this message.
5. AutoStar then displays: "Location Option: 1-Zipcode 2-City". This option allows you to choose how you wish to enter the location of your observing site: you can enter your zip code or choose the site from a list of countries, states and cities.  
Press the number key "1" if you wish to enter by zip code. Then enter the five digits of the zip code of your observing site and press ENTER.  
Press the number key "2" if you wish to select your observing site from a list of country, states and cities. First, use a Scroll key to cycle through the list of countries and states (listed alphabetically). Press ENTER when the correct location displays. Next, use a Scroll key to cycle through the list of cities (also listed alphabetically). Press ENTER when the closest city displays.
6. Finally "Telescope Models" displays. Using the SCROLL KEYS, cycle through the list of telescope models and press ENTER when your model displays.
7. The display now displays "Align: Automatic."

You can now use the ARROW KEYS to slew (move) the telescope up, down, right or left. Practice using the ARROW KEYS to center objects in the eyepiece. To change the speed at which the telescope moves (known as the "slew" speed), press a NUMBER KEY from 1 through 9. 1 is the slowest speed and 9 is the fastest.

### Note:

Viewing conditions vary widely from night-to-night and site-to-site. Turbulence in the air, even on an apparently clear night, can distort images. Low-power eyepieces, such as the 26mm supplied with your telescope, are better suited to resolving images in poor viewing conditions.



**NEVER point the telescope directly at or near the Sun at any time! Observing the Sun, even for the smallest fraction of a second, will result in instant and irreversible eye damage, as well as physical damage to the telescope itself.**

**Do not look through the telescope's eyepiece while it is rapidly moving. Children should always have adult supervision while observing.**

### Important Note:

AutoStar requests the Country/State, City and Telescope Model information **only the first time** AutoStar is activated. Subsequently, AutoStar uses the location and model number you have chosen.

If you wish to change this information, use the "Telescope Model" and "Site" options in the Setup menu. See pages 27 and 29 for more information.

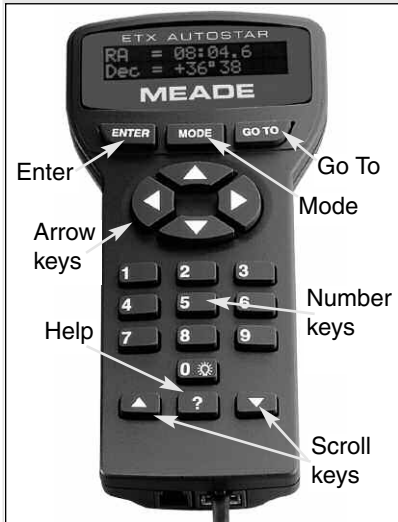

Fig. 21: AutoStar keys.

**Tip:**

When multiple choices are available within an AutoStar Menu option, the current option is usually displayed first and highlighted by a right pointing

## Slew Speeds

AutoStar has nine slew speeds that move the optical tube at rates that are directly proportional to the sidereal rate and have been calculated to accomplish specific functions. Press the Number key to change the slew speed.

The nine available speeds are:

Number Key 1	=	1x	=	1 x sidereal (0.25 arc-min/sec or 0.004°/sec)
Number Key 2	=	2x	=	2 x sidereal (0.5 arc-min/sec or 0.008°/sec)
Number Key 3	=	8x	=	8 x sidereal (2 arc-min/sec or 0.033°/sec)
Number Key 4	=	16x	=	16 x sidereal (4 arc-min/sec or 0.067°/sec)
Number Key 5	=	64x	=	64 x sidereal (16 arc-min/sec or 0.27°/sec)
Number Key 6	=	128x	=	30 arc-min/sec or 0.5°/sec
Number Key 7	=	1.0°	=	60 arc-min/sec or 1.0°/sec
Number Key 8	=	1.5°	=	90 arc-min/sec or 1.5°/sec
Number Key 9	=	Max	=	approx. 4.5°/sec

**Speeds 1, 2 or 3:** Best used for fine centering of an object in the field of view of a higher power eyepiece, such as a 9mm eyepiece.

**Speeds 4, 5 or 6:** Enable centering of an object in the field of a low-to-moderate power eyepiece, such as a 26mm.

**Speeds 7 or 8:** Best used for rough centering of an object in the SmartFinder.

**Speed 9:** Moves the telescope quickly from one point in the sky to another.

## Astronomical Observing

Used as an astronomical instrument, your telescope has many optical and electro-mechanical capabilities. It is in astronomical applications where the high level of optical performance is readily visible. The range of observable astronomical objects is limited only by the observer's motivation.

## Observe the Moon

Point your telescope at the Moon (note that the Moon is not visible every night) and practice using the Arrow keys and the slew speeds to view different features. The Moon contains many interesting features, including craters, mountain ranges and fault lines. The best time to view the Moon is during its crescent or half phase. Sunlight strikes the Moon at an angle during these periods and adds a depth to the view. No shadows are seen during a full Moon, making the overly bright surface appear flat and rather uninteresting. Try using a neutral density Moon filter when observing the Moon (see **OPTIONAL ACCESSORIES**, page 42). Not only does it cut down the Moon's bright glare, but it also enhances contrast, providing a more dramatic image.

## To Track an Object Automatically

As the Earth rotates beneath the night sky, the stars appear to move from East to West. The speed at which the stars move is called the sidereal rate. You can setup your telescope to move at the sidereal rate so that it automatically tracks (follows) the stars and other objects in the night sky. If the telescope is not tracking an astronomical object, the object will drift out of the eyepiece field of view. The tracking function automatically keeps an object centered in the telescope's eyepiece.

To automatically track objects, you need to learn how the AutoStar keypad operates in order to move through its menus. You'll also need to initialize and align your telescope.

## Moving Through AutoStar's Menus

The AutoStar database is organized in levels for quick and easy navigation.

- Press ENTER to go deeper into AutoStar's menu levels.
- Press MODE to move back toward the top menu level.
- Press the Scroll keys to move up and down through the options available for each level.
- Press the Arrow keys to enter characters and digits. The Arrow keys are also used to move the telescope.



**Definition:**

**Initialization** is a procedure that makes sure that AutoStar operates correctly. When you first use AutoStar, it doesn't yet know where the observation location site is. AutoStar also needs to know the time and date, which is set at the factory and may also be reset using Meade's optional Atomic Clock Update Module accessory.

AutoStar uses this information (along with detecting tilt, level and North) to precisely calculate the location of celestial objects (such as stars and planets) and to move your telescope correctly for various operations.

**Note:**

Throughout this manual, you will notice the term "alt/az." Alt/az is frequently used to refer to altitude (vertical) and azimuth (horizontal). Alt/az is just one of many methods used by amateur astronomers to help locate stars in the night sky.

Another method of alignment is called "Equatorial" (also known as "Polar"). To learn more about equatorial alignment, see page 50.



**Fig. 22:** The vertical lock.



**Fig. 23:** The horizontal lock.

## Initializing AutoStar for the First Time

This section describes how to initialize AutoStar. Perform this procedure the first time you use AutoStar or after performing a Reset (see **RESET**, page 28).

AutoStar will ask you to choose your observing location and your telescope's model number from the list it displays. You will be prompted to enter this information **only the first time you use AutoStar**. If you wish to change your location information (or if AutoStar does not ask you for this information the first time that you use it), go to the Site option of the Setup Menu to select your location. See pages 27 and 29 for more information.

1. Tighten the vertical and horizontal locks (**6, Fig. 1b** and **9, Fig. 1a**) if necessary.
2. Make sure that AutoStar is connected to the HBX port (**C, Fig. 2**) of the telescope's computer control panel.
3. Flip the telescope power switch (**A, Fig. 2**) to the ON position.  
The AutoStar screen displays a copyright message, followed by a short beep. Then AutoStar takes a few moments to start up the system.
4. A message displays that warns not to look at the Sun. At the end of this message, press the key prompted by AutoStar to signify that the message has been read and understood.
5. The Getting Started menu displays a scrolling message. Press ENTER (**2, Fig. 4**) to bypass the Help tutorial and continue with initialization.
6. AutoStar then displays: "Location Option: 1-Zipcode 2-City". This option allows you to choose how you wish to enter the location of your observing site: you can enter your zip code or choose the site from a list of countries, states and cities.  
Press the number key "1" if you wish to enter by zip code. Then enter the five digits of the zip code of your observing site and press ENTER.  
Press the number key "2" if you wish to select your observing site from a list of country, states and cities. First, use a Scroll key to cycle through the list of countries and states (listed alphabetically). Press ENTER when the correct location displays. Next, use a Scroll key to cycle through the list of cities (also listed alphabetically). Press ENTER when the closest city displays.
7. AutoStar then requests the telescope model number. Use the Scroll keys to cycle through the database of models. Press ENTER when your model number displays.
8. System initialization is complete and the screen reads "Align: Automatic."

## Automatic Alignment

After initializing, AutoStar will automatically align your telescope for you. AutoStar is in the alt/az mode (**see the margin Note to the left**) by default the first time you power it on, so you do not need to select this mode. If you wish to align your telescope in the equatorial (polar) mode, see **EQUATORIAL ALIGNMENT**, page 50.

During automatic alignment, you will be asked to set the telescope in the home position. Then AutoStar will automatically detect the level position and the tilt of your telescope, and also detects North (note that the telescope may *not* be pointing North after it does so).

After finding North, AutoStar picks two stars from its database. AutoStar moves the telescope to the first alignment star and the user is asked to center the star in the eyepiece. The process is then repeated with a second star to complete the alignment. The following explains in detail how to perform the alt/az automatic alignment procedure.

### How to perform the Automatic Alignment procedure

1. **Set Home Position:** AutoStar then prompts you to set the telescope in the Alt/Az Alignment home position. To set your telescope in the Alt/Az home position when using the Automatic Alignment menu:
  - If necessary, tighten the telescope's vertical lock (**6, Fig. 1b**).
  - Unlock the horizontal lock (**9, Fig. 1a**). This will allow you to rotate the telescope tube and fork arm assembly.



Fig. 24 [top view]: Rotate the telescope tube counterclockwise until it stops.

**Important Note:** The home position for Automatic Alignment is **different** than the home position used with One Star and Two Star Alt/az alignments. See page 36 for setting the Home Position during One Star and Two Star Altaz

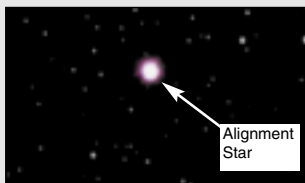

Fig. 25: During alignment, the alignment star is always the brightest star in the area of the sky at which the telescope is pointing.

**Important Note:** While performing the automatic tracking procedure, only use the Arrow keys to move the telescope. Once the telescope has been aligned, do not loosen the telescope's vertical or horizontal locks (6 and 9, Fig. 1a and 1b) or move the base manually or alignment will be lost.

- Grasp the telescope by a fork arm and rotate the telescope counterclockwise until it stops (Fig. 24).
  - Re-lock the horizontal (9, Fig. 1a) and vertical locks (6, Fig. 1b).
2. **Level, Tilt and Find North:** Next your telescope begins to move. AutoStar moves your telescope so that it can calculate the level position and tilt of your telescope, and also calculate the location of True North. While it is performing these functions, the following messages will appear on AutoStar's display: "Calc Level," "Calc North" and "Calc Tilt."

**Note:** During this step in the procedure, the telescope may not become level or actually point to North. AutoStar is merely moving the telescope about so that it can calculate these positions.

3. **Star Alignment:** Next, AutoStar continues to move the telescope (you don't need to press any buttons) in order to choose two stars for alignment. AutoStar will display a name of a star and the word "Slewing" as it moves to the first star. It will then prompt you to center the star.

However, when the telescope slews to the first star, it may not appear in the field of view in the eyepiece. Use the SmartFinder (2, Fig. 1a) to locate the star. The alignment star will be easy to recognize—it will be the brightest star in the area of the sky where the telescope is pointing. Look through the SmartFinder and use the Arrow keys to move the telescope until the star is visible. Then look through the eyepiece and center the star using the Arrow keys. Press ENTER. Repeat the procedure for the second alignment star.

When the procedure is performed correctly, "Alignment Successful" displays. If AutoStar does not display this message, perform this procedure again.

**NOTE:** The alignment stars may change from night to night. All that is required is for the observer to center the selected stars in the eyepiece when prompted.

## Observe a Star using the Automatic Tracking Feature

In this example, the AutoStar Arrow keys are used to find a star and then AutoStar's tracking feature automatically keeps the star centered in your telescope's eyepiece. Make sure you have initialized and aligned your telescope before you try out this feature (see page 17).

1. Once your telescope has been aligned, "Align Successful" and then "Select Item: Object" display. Push the Scroll Up key once and "Select Item: Setup" displays
2. Press ENTER. "Setup: Align" displays.
3. Press the Scroll Down key repeatedly until "Setup: Targets" displays. Press ENTER.
4. "Targets: Terrestrial" displays. Press one of the Scroll keys once. "Targets: Astronomical" now displays.

### ETX TIPS

#### Which One's the Alignment Star?

If you're not familiar with objects in the night sky, how can you be sure if the star in your eyepiece is really the alignment star?

The rule of thumb is that an alignment star is usually the brightest star in that area of the sky. If you perform a GO TO to an alignment star and you're not sure if you have located the alignment star or it isn't in the eyepiece, look through your smartfinder. When you view an alignment star in the SmartFinder, it stands out dramatically from the rest of the stars in that portion of the sky. The SmartFinder will help you locate a star more quickly than the eyepiece. Using AutoStar, set the slew speed to 6 (press Number key 6) or higher and use the Arrow keys to center the alignment star in the SmartFinder. If your SmartFinder has been aligned with the telescope, the alignment star should now be in the eyepiece. Set the slew speed to 4 or less and center the star in the eyepiece. Also see the SPIRAL SEARCH tip, page 19.

**Tip:**

The GO TO key also allows you to perform a "spiral search." A spiral search is useful when the telescope slews to an object, but that object is not visible in the eyepiece after the telescope finishes its search. (This sometimes occurs during an alignment procedure.)

Press GO TO when the telescope stops slewing. The telescope begins to move in a spiral pattern at a very slow speed around the search area. When the object does become visible, press MODE to stop the spiral search. Then use the Arrow keys to center

**Important Note:**

The first time you use your telescope or if you are experiencing any problems with pointing accuracy, follow the procedure described in **APPENDIX C: TRAINING THE DRIVE**, page 55, to insure accurate pointing and tracking.

**Tip:** Try out the Guided Tour feature; the "Tonight's Best" Guided Tour will point your telescope at the best objects visible in the sky for every given night of the year. The objects in this tour may change from night to night.

You can easily create your own Guided Tour using the optional Meade's AutoStar Suite software. See **PHOTOGRAPHY WITH MEADE'S AUTOSTAR SUITE**, page 41 for more information.

5. Use the Arrow keys (**5, Fig. 2**) to locate a bright star in the night sky. Use the smartfinder (**2, Fig. 1a**) to help line up on the star. You may choose any unobstructed, bright star for the purposes of this example. Use AutoStar's Arrow keys to center the star in the eyepiece. Once the star is centered, press ENTER to select "Astronomical." The telescope's tracking motors then engage. It may take the tracking motors several seconds to begin tracking. When they do, it may be necessary to once again center the star in the eyepiece. The tracking motors will then keep the star you have chosen in the center of the eyepiece.
6. Press and hold the ENTER key for a few seconds and then release to stop tracking. You may repeat the procedure to locate another star or object using the Arrow keys. Then press ENTER to re-engage the tracking motors.

## Go To Saturn

After performing the Automatic Alignment procedure, the motor drive begins operating and the telescope is aligned for a night of viewing. Objects in the eyepiece will maintain their position even though the Earth is rotating beneath the stars.

This exercise demonstrates how to select a celestial object, the planet Saturn, for viewing from AutoStar's database.

**NOTE:** Saturn is not visible the entire year and you may need to choose another object from AutoStar's database; however, the procedure, as described below, remains the same. If Saturn (or any other object) is not currently visible in the sky, AutoStar displays "Below Horizon."

1. After the telescope is aligned, "Select Item: Object" displays. If "Select Item: Object" is not displayed on your handbox, keep pressing MODE until it does display. Press ENTER.
2. "Object: Solar System" displays. Press ENTER.
3. "Solar System: Mercury" displays. Keep pressing the Scroll Down key until "Solar System: Saturn" displays (or you may choose another object from the Solar System list if Saturn is not visible).
4. Press ENTER. "Calculating" displays. Then "Saturn" and a set of coordinates displays. Note that Saturn's (and other planets') coordinates change throughout the year.
5. Press GO TO. "Saturn: Slewing..." displays and the telescope slews until it finds Saturn. You may need to use the Arrow keys to center Saturn precisely in the eyepiece. AutoStar then automatically moves the telescope so that it "tracks" Saturn (or whatever other object you may have chosen); i.e., Saturn remains centered in the eyepiece.

## Using the Guided Tour

This example demonstrates using "Tonight's Best" Guided Tour.

1. After observing Saturn, press MODE twice so that "Select Item: Object" displays again.
2. Press the Scroll Down key twice. "Select Item: Guided Tour" displays.
3. Press ENTER. "Guided Tour: Tonight's Best" displays. Press ENTER.

**NOTE:** If you wish to try out other Guided Tours, press the Scroll Down key to scroll through other tour choices. When the tour you wish to select displays, press ENTER.
4. "Tonight's Best: Searching..." displays. After calculating, "Tonight's Best: Jupiter" displays.

**NOTE:** Different objects may be displayed on a tour list on any given night. Tour objects are selected based on location's time and date.

Press ENTER to display information about the object. Press GO TO to move the telescope to the object.
5. Press MODE to return to the Tour list. Press the Scroll keys to scroll through the list. Press ENTER when you find the next object you wish to observe.
6. Press and hold down MODE for two seconds to leave the Guided Tour menu.

# AUTOSTAR OPERATION

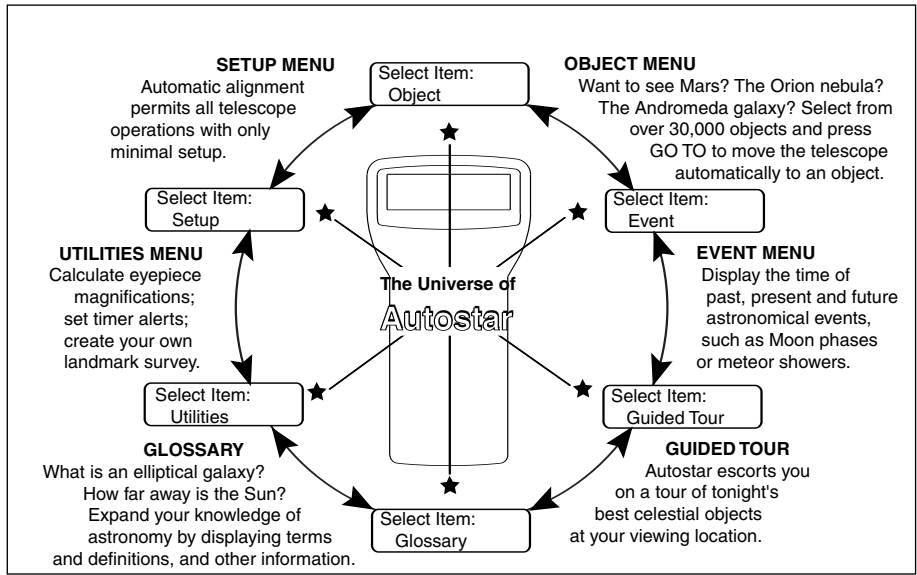

Fig. 26: The AutoStar Universe: The six primary categories listed in the Select menu.

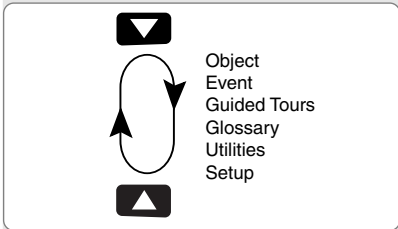

Fig. 27a: Menus set in a loop.



Fig. 27b: Menu options display on the second line. Use the Scroll keys to move up or down through the list of options. Press ENTER to select the desired option.

It is important to understand that menu selections are set in a loop (**Fig. 27a**). This means that pressing the Scroll Down key cycles down through all the available options within a given category, then returns to the first option. The Scroll Up key cycles up through the options in the opposite order. Note that this capability is a quick way to get to an option that is near the bottom of the list. The following example demonstrates this capability.

**Example:**

To navigate to the “Select Item: Setup” menu option when the “Select Item: Object” menu is displayed:

1. Press the Scroll Down key four times or the Scroll Up key once.

The screen in **Fig. 27b** shows two lines of information in the AutoStar display. The top line shows the current menu level. The second line displays an option which may be selected. Some options are submenus that offer more choices. The Scroll keys move up and down within the list of available options, showing one option at a time.

When an option is displayed on the second line, press the ENTER key to choose that option.

Press the MODE key to return back to the last menu. This can be useful to exit a menu or if the wrong menu option is chosen.

**IMPORTANT NOTE:** No matter how many levels into AutoStar are traveled, each press of the MODE key moves up a level, until the top level, “Select Item,” is reached. Once Select Item displays, press MODE to return to the topmost level, “Select Item: Object.”

## AutoStar Navigation Exercise

To demonstrate how the AutoStar menu structure works, the following exercise calculates Sunset time so an evening observing session can be planned.

**NOTE:** To perform an accurate calculation, AutoStar **MUST** be properly initialized with the location of the observing site. See **INITIALIZING AUTOSTAR**, page 17, before proceeding with this exercise.

**To Calculate Sunset time:**

1. Press the MODE key several times, until “Select Item: Object” is displayed.
2. Press the Scroll Down key once to display the “Event” option in the “Select Item” menu.

**Tip:**

*When multiple choices are available within a menu option, the current option is usually displayed first and highlighted by a right pointing arrow (>).*

3. Press the ENTER key to choose the "Event" option and move down a level. "Event: Sunrise" is displayed.
4. Press the Scroll Down key once to display the "Sunset" option in the Event menu.
5. Press the ENTER key to choose the "Sunset" option and move down another level.
6. AutoStar calculates the Sunset time based on the current date, time and location. AutoStar then displays the results of the calculation.
7. Press MODE once to start moving back up through the AutoStar levels. The first level up is the Event menu.
8. Press MODE again to move up another level. This is the top level, "Select Item."
9. Press MODE again to return to the starting point of "Select Item: Object."

### Entering data into AutoStar

- To enter numbers and text:
  - a) Use the Number keys, or
  - b) Use the Arrow keys to scroll through numbers 0 - 9 and the alphabet. The Down Arrow key begins with the letter "A;" the Up Arrow key begins with digit "9."
- To move the cursor across the display:

Use the Right or Left Arrow key to move the cursor from one number to the next in the display.
- Press ENTER when the desired information has been entered.

### Moving Through AutoStar's Menus

AutoStar's menus are organized for quick and easy navigation:

- Press ENTER to go deeper into AutoStar's menu levels.
- Press MODE to move back toward the top menu level.
- Press the Scroll keys to move up and down through the options or lists.
- Press the Arrow keys to move the cursor across the display.
- Press the Help (?) key to access on-line help.

## ETX TIPS

### Look into the Future

The Date option in the Setup menu is much more than just an entry of today's date; with it you can look far into the future or learn about past events. AutoStar can calculate the date and times of future events and, except for eclipses, past events as well (based on the current calendar system). *E.g.*, a Sunrise on March 6, 2043 A.D. or the Vernal Equinox in 1776 A.D. To use this feature, enter the desired date in the Setup menu or select an option in the Event menu.

AutoStar, using the Event menu, can calculate dates and times for Sunrises, Sunsets, Moonrises, Moonsets, Moonphases, Solar and Lunar Eclipses (for the next 100 years), meteor showers, equinoxes and solstices and the minimums of Algol.

One very practical use of the Event menu is to check the Sunset option to determine when you can begin your astronomical observing session.

# AUTOSTAR'S MENUS

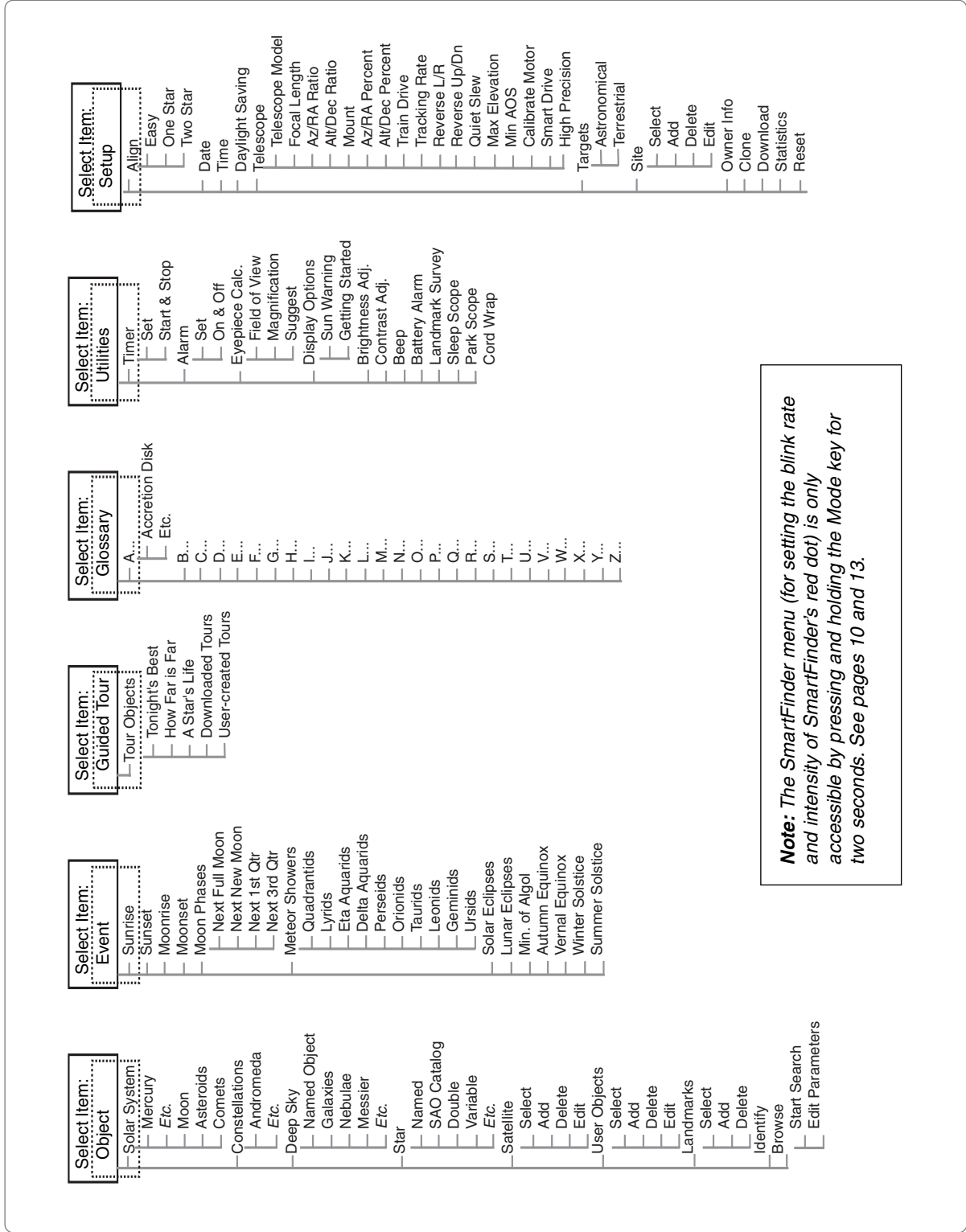

**Note:** The SmartFinder menu (for setting the blink rate and intensity of SmartFinder's red dot) is only accessible by pressing and holding the Mode key for two seconds. See pages 10 and 13.

Figure 28: The Complete AutoStar Menu Tree Structure.

Use the **OBJECT** menu to select an object from the database.

When your telescope is aligned and you select an object from any of these lists, you just need to press the GO TO key to move the telescope so that it is pointed at the selected object.

Over 30,000 objects are available for ETX-90PE, ETX-105PE and ETX-125PE models.

The available objects include planets, constellations, individual stars, double stars, star clusters, galaxies, quasars, satellites, asteroids and comets.

Also, try out the Guided Tour feature; the "Tonight's Best" Guided Tour will point your telescope at the best objects visible in the sky for every given night of the year.

Want to learn more about **Observing Satellites**? See page 32.

Want to learn more about **Landmarks**? See page 34.

## Object Menu

Almost all observing with AutoStar is performed using the Object menu category. (*The two exceptions are the Guided Tours and Landmark Survey.*) See **GO TO SATURN**, page 19, for an example of observing using the Object menu. Also see **USING THE GUIDED TOUR**, page 19.

Many AutoStar menu categories contain lists or databases. The AutoStar object *database* is a list of viewable objects, such as stars, planets, comets, nebulae and so forth. When one of these objects is selected from the object database and is above the horizon, AutoStar moves your telescope (if properly aligned) and points it at the selected object.

**Note:** *Most celestial objects are visible in the sky for only part of the night and also only visible part of the year. If an object is not visible on the night you are observing, AutoStar displays a message that the object is below the horizon.*

### The Object Menu options include:

**Solar System** is a database of the eight planets (Earth is not included) in order out from the Sun, followed by the Moon, asteroids and comets.

**Constellation** is a database of all 88 Northern and Southern Hemisphere constellations. To use this menu:

1. When this menu option is chosen and "Andromeda" displays, use the Scroll keys to scroll through the constellation list.
2. Press ENTER to select a constellation and to display the coordinates of the constellation. Press one of the Scroll keys and information about the constellation will scroll across the display screen.
3. Press GO TO to display the list of stars in the constellation. Use the Scroll keys to scroll through the list of stars in the constellation, from the brightest to dimmest.
4. Press ENTER to select a star and use the Scroll keys to display information about the star. Press GO TO again to slew the telescope to that star.

**Note:** Use **MODE** to abort any of these operations.

**Deep Sky** is a database of objects outside our Solar System such as nebulas, star clusters, galaxies and quasars.

**Star** is a database of stars listed in different categories such as named, double, variable or nearby.

**Satellite** is a database of Earth-orbiting objects such as the International Space Station, the Hubble Space Telescope, Global Positioning System (GPS) satellites and geosynchronous orbit satellites.

**User Objects** allows the user to define and store in memory deep-sky objects of specific interest that are not currently in the AutoStar database. See page 30 for more information.

**Landmarks** stores the location of terrestrial points of interest in the permanent AutoStar database.

**IMPORTANT NOTE:** *To use the Landmark function, the telescope must be located and aligned exactly as when the landmark was added to the database.*

- **Select:** To select a Landmark already in the database (see **ADD** below), choose the "Select" option and scroll through the list. Press ENTER to select a Landmark, then press GO TO and the telescope slews to the object.
- **Add:** To add a Landmark, choose the "Add" option. Enter a name for the Landmark. Locate and center the Landmark in the eyepiece, then press ENTER.

**Identify** is an exciting feature for an observer who wants to scan the night sky and start exploring. After the telescope has been properly aligned, use the AutoStar Arrow keys to move about in the sky. Then follow this procedure:



Want to learn more about using the **Browse menu**? See page 38.

Use the **Event menu** to look up dates of various astronomical events, such as sunrises and sunsets, eclipses, moon phases, meteor showers, equinoxes and solstices...

...and not just for the current date. Set any date, past or future, when initializing AutoStar and you can check the time for other events.



**WARNING!**  
Never use  
your ETX  
Telescope to

look at the Sun! Looking at or near the Sun will cause instant and irreversible damage to your eye. Eye damage is often painless, so there is no warning to the observer that damage has occurred until it is too late. Do not point the telescope at or near the Sun. Do not look through the telescope as it is moving. Children should always have adult supervision while observing.

Use the **Glossary menu** to look up definitions of astronomical terms and get a description of AutoStar features.

#### **IMPORTANT NOTE FOR ALL ALIGNMENT-BASED OPERATIONS:**

Only use the Arrow keys to move the telescope during the Identify procedure. Do not loosen the telescope locks or move the base or the alignment will be lost.

1. When a desired object is visible in the eyepiece, keep pressing MODE until the "Select Item: Object" menu is displayed. Press ENTER to select this menu.
2. Scroll through the Object menu options until the "Object: Identify" screen appears.
3. Press ENTER. AutoStar searches the database for the identity of the object being observed.
4. If the telescope is not directly on an AutoStar database object, the nearest database object is located and displayed on the screen. Press GO TO and the telescope slews to that object.

**Browse** allows you to search the database for objects with certain parameters, much like a search engine. "Edit Parameters" lets you set various parameters for the search, such as: Object Type, Minimum Elevation, Largest, etc. Once you have set the parameters of the search, select "Start Search" and press ENTER. AutoStar will display the results of the search.

### Event Menu

The Event menu provides access to dates and times of astronomical events. The Event database includes:

**Sunrise** and **Sunset** calculates the time that the Sun rises or sets on the current date. Find rise and set times for other dates by entering a new date into the "Setup: Date" menu. See **DATE**, page 26 and also see **ETX TIPS**, page 21.

**Moonrise** and **Moonsset** calculates the time that the Moon rises or sets on the current date. Find rise and set times for other dates by entering a new date into the "Setup: Date" menu. See **DATE**, page 26 and also see **ETX TIPS**, page 21.

**Moon Phases** displays the date and time of the next Full, New, 1st Quarter and 3rd Quarter Moon.

**Meteor Showers** provides information on upcoming meteor showers, such as the Perseids, the Leonids, etc. Also lists the dates of the showers and when they reach maximum.

**NOTE:** Meteors are fast moving objects that cover large areas of the sky and are usually best observed with the naked eye.

**Solar Eclipse** lists upcoming Solar Eclipses, including the date and type (total, annular or partial) of eclipse and the location and time of the first and last contacts of the Moon's shadow. Use the Scroll Up and Down keys to display the available data. Remember, never use a telescope to look at the Sun! See **WARNING!** to the left.

**Lunar Eclipse** lists upcoming Lunar Eclipses, including the date and type (total, partial, penumbral) of eclipse. Use the Scroll Up and Down keys to display the available data.

**Min. (Minimum) of Algol** is the minimum brightness of the dramatic eclipsing binary star system, Algol. It is relatively close at a distance of 100 light years. Every 2.8 days during a 10-hour period, Algol undergoes a major change in apparent magnitude as one of the two stars passes behind the other. The combined magnitude of the two stars thus dips from +2.1 to a minimum of +3.4 halfway through the eclipse as the second star is hidden. AutoStar calculates minimum magnitude time at mid-eclipse.

**Autumn** and **Vernal Equinox** calculates the time and date of the fall or spring equinox of the current year.

**Winter** and **Summer Solstice** calculates the time and date of the winter or summer solstice of the current year.

### Glossary Menu

The Glossary menu provides an alphabetical listing of definitions and descriptions for common astronomical terms and AutoStar functions. Access directly through the Glossary menu or through hypertext words embedded in AutoStar. A *hypertext word*



Use the **Utilities menu** to perform many of AutoStar's useful features, such as setting an alarm, adjust the display contrast, calculate the best eyepiece for viewing an object, set up your own landmark survey, and so forth.

**Tip:**  
The Contrast Adjustment feature is usually only required in very cold weather.

If you adjust the contrast so that you can no longer read the display, turn off the power and turn it on again. When Version appears on the display (the initial display screens are not affected by the Contrast control), press **MODE**.

**Tips:**  
To use the Landmark function, the telescope must be located and aligned exactly as when the landmark(s) was added to the database.

To add objects to the Landmark database, the telescope must be located and aligned exactly as when the original objects were added to the database.

is any word in **[brackets]**, usually found when using the AutoStar Help function or when reading a scrolling message such as a description of a planet or star. Press **ENTER** whenever a hypertext word is on screen and AutoStar goes to the glossary entry for that word.

To access directly from the Glossary menu, use the Scroll keys to scroll through the alphabet. Press **ENTER** on the desired letter. Scroll to the desired entry and then press **ENTER** to read the description.

## Utilities Menu

The Utilities menu provides access to several extra features within AutoStar, including a countdown timer and an alarm. The Utilities functions include:

**Timer** selects a countdown timer. This feature is useful for functions such as astrophotography and tracking satellites. See **OBSERVING SATELLITES**, page 30. To use the Timer, press **ENTER**, then choose "Set" or "Start/Stop."

- **Set:** Enter the time to be counted down, in hours, minutes and seconds, then press **ENTER**.
- **Start/Stop:** Activates the timer set previously. Use the Scroll keys to toggle between **ON** and **OFF**. When **ON** is displayed, press **ENTER** to activate the timer. When the timer runs out, four beeps sound and the timer is deactivated.

**Alarm** selects a time for an alarm signal as a reminder. To use the Alarm, press **ENTER**, then choose "Set" or "Start/Stop."

- **Set:** Enter the time of day for the alarm to sound, in hours, minutes and seconds, then press **ENTER**.
- **Start/Stop:** Activates the alarm set previously. Use the Scroll keys to toggle between **ON** and **OFF**. When **ON** is displayed, press **ENTER** to activate the alarm. When the alarm time arrives, AutoStar beeps. Press **ENTER** to deactivate the alarm.

**Eyepiece Calc** calculates information about an eyepiece for the specific telescope to which AutoStar is connected.

- **Field of View:** Scroll through a list of available eyepieces. When an eyepiece is selected, the field of view is calculated.
- **Magnification:** Scroll through a list of available eyepieces. When an eyepiece is selected, the magnification is calculated.
- **Suggest:** AutoStar calculates and suggests the best eyepiece for viewing, based on the telescope and the object being viewed.

**Display Options** enables or disables AutoStar's two initial displays. If both displays are disabled, AutoStar begins with the Date display.

- **Sun Warning:** Turns the **SUN WARNING** message on or off.
- **Getting Started:** Turns the **GETTING STARTED** message on or off.

**Brightness Adj:** Adjusts the brightness of the display using the Scroll keys. When complete, press **ENTER**.

**Contrast Adj:** Adjusts the contrast of the display using the Scroll keys. When complete, press **ENTER**.

**NOTE:** This feature is usually only required in very cold weather.

**Beep:** Turns the beep on or off.

**Landmark Survey** automatically slews the telescope to all user-defined landmarks with a short pause at each location. Press **ENTER** to start the survey. While a slew is in progress, press any key to skip that object and go to the next landmark on the list. To observe a landmark for a longer period, press **MODE** when paused on the object to stop the survey. Press **ENTER** to restart the survey at the first object on the list. See **LANDMARKS**, page 34, for information about creating a Landmark survey.

Use the **Setup menu** to perform many of the features that apply to the set up of your telescope, such as training the drive, selecting terrestrial or astronomical modes, changing observing site information.

**Sleep Scope** is a power saving option that shuts down AutoStar and the telescope without forgetting its alignment. With "Sleep Scope" selected, press ENTER to activate the Sleep function. AutoStar goes dark, but the internal clock keeps running. Press any key, except ENTER, to re-activate AutoStar and the telescope.

**Park Scope** is designed for a telescope that is not moved between observing sessions. Align the telescope one time, then use this function to park the telescope. Next time it is powered up, pressing ENTER and the telescope moves to its pre-determined Park position. Once parked, the screen prompts to turn off power.

**IMPORTANT NOTE:** When the "Park Scope" option is chosen and the display prompts you to turn off the telescope's power, AutoStar is unable to be returned to operation without turning the power off and then back on.

**Cord Wrap**, when set to "On," moves the telescope in such a way as to prevent the cords and cables attached to your telescope assembly from getting wound around the assembly and tangled as the telescope slews to objects. "Off" is the default setting.

## Setup Menu

The Setup menu's primary function is to align the telescope (see **AUTOMATIC ALIGNMENT**, page 17). However, there are numerous other features available within the Setup menu, including:

**Date** changes the date used by AutoStar. This function is useful to check events in the past or future. For example, set the Date menu for a day three months in the future. Then check the "Select Item: Event" menu for the Sunset time on that date. See **EVENT MENU**, page 24.

**Time** changes the time entered into AutoStar. Setting the correct time is critical for AutoStar to properly calculate locations and events. Time may be set to 24-hour mode (military time) by selecting the "blank" option which follows the "AM" and "PM" options.

**Daylight Saving** is used to enable or disable Daylight Savings time.

**NOTE:** Daylight Savings Time may be referred to by different names in various areas of the world. Check local time to verify.

**Telescope** accesses the several options, including:

- **Model:** Allows you to select the telescope model connected to AutoStar.
- **Focal Length:** Displays the focal length of the selected telescope.
- **Az/RA Ratio and Alt/Dec Ratio:** The ratios refers to the gears of the telescope's motors. **Do not alter these numbers.**
- **Az/RA Percent:** The Az (Azimuth)/RA (Right Ascension) Percent allows you to adjust the amount of *azimuth backlash* taken out by AutoStar. Azimuth backlash is the way the Arrow keys move the telescope along the azimuth (horizontal) axis. If you enter a value near 100, the telescope tube responds more quickly (it responds immediately at 100%) as you hold down an Arrow key and also slews (moves) the tube more quickly. If you enter a value near 0, it takes longer for the tube to respond as you hold down an Arrow key and also slews the tube more slowly. Experiment with this option. Try changing the percent value until you get a "feel" for the Arrow keys that is comfortable for you.
- **Alt/Dec Percent:** The Alt (Altitude)/Dec (Declination) Percent operates identical to the Az/RA Percent option (see above), but allows you to adjust the *altitude backlash*, *i.e.*, the way the Arrow keys move the telescope when moving along the altitude (vertical) axis.
- **Train Drive:** Trains the Altitude and Azimuth motors to locate objects with more precision.

The first time you use your telescope or if you are experiencing any problems with pointing accuracy, follow the procedure described in **APPENDIX C: TRAINING THE DRIVE**, page 55, to insure accurate pointing and tracking.

Want to learn more about **Periodic Error Correction**? See page 37.

**Tip:** If the "ENTER to Sync" feature is accessed by mistake (holding the ENTER key for more than 2 seconds), press MODE to return to the previous screen.

- **Tracking Rate:** Changes the speed at which the telescope tracks targets in the sky.
  - a. **Sidereal:** The default setting for AutoStar; sidereal rate is the standard rate at which stars move from East to West across the sky due to the rotation of the Earth.
  - b. **Lunar:** Choose this option to properly track the Moon over long observing sessions.
  - c. **Custom:** Allows entry of user-defined tracking rates.
- **Reverse L/R:** Reverses the functions of the Left and Right Arrow keys (*i.e.*, the Right key moves the telescope to the left).
- **Reverse UP/DOWN:** Reverses the functions of the Up and Down Arrow keys (*i.e.*, the Up key moves the telescope down).
- **Calibrate Sensors:** This menu allows you to improve your telescope's pointing accuracy to alignment stars. It calibrates to correct slight mechanical misalignment due to transport, vibration, or aging. It is recommended that calibration be performed after the LNT Module batteries are changed (see page 56 for more information).

When this menu is selected, the telescope slews to Polaris. AutoStar then prompts you to center Polaris and to press ENTER. AutoStar uses the position of Polaris to fine tune the position of North and also for detecting level.
- **Quiet Slew:** Sets the maximum slew rate to 1.5° for quieter operation.
- **Max Elevation:** Allows you to enter a value in degrees that sets a limit as to how far the optical tube can swing upward during a programmed slew. (Note that it does not prevent you from performing a manual slew past this limit.) This is useful when you have a camera or other peripheral attached to the telescope—you can prevent it from striking the telescope base.
- **Min AOS (Acquisition of Signal):** Allows you enter a value in degrees. This value represents the altitude at which your telescope begins to slew when acquiring a satellite track. This is useful when you are observing satellites, but a tall tree or building is obstructing the telescope. For example, you might begin to track the satellite at 15° altitude, instead of 5°. See **OBSERVING SATELLITES**, page 30, for more information about satellites.
- **Calibrate Motor:** If the telescope motors appear to have a problem, use this option to retest the motors before performing a Reset. This option is also used if an AutoStar unit is moved between telescopes, to match AutoStar to the new telescope. To calibrate the motors, select this option and press ENTER.
- **Smart Drive:** Allows you to perform periodic error correction (PEC) on the R.A. worm gear and can only be used with polar mounted telescopes. Must be performed with a high powered reticle (*eg. 9mm*). PEC Training for the the ETX telescopes will take about 24 minutes.
- **High Precision:** If High Precision is turned on, when looking for a faint celestial object (*i.e.*, a nebula or galaxy), AutoStar first slews to a nearby bright star and displays "ENTER to Sync." Center the star in the eyepiece, then press ENTER. At that point the telescope has a high precision alignment to that part of the sky and it then slews to the object that was originally requested.

**Targets** switches between Astronomical targets and Terrestrial targets. If "Astronomical" is selected, the telescope tracking motor is activated and any object you observe will remain centered in the eyepiece. If "Terrestrial" is selected and the telescope is aligned, the tracking motor is turned off. To learn how to track an object automatically, see page 16.

**Site** provides access to several options including:

- **Select:** Displays the currently selected observing site or zip code. Use the Scroll keys to cycle through all the sites. Press ENTER when the site you wish to select displays. Use this option when you move to a different geographic location. The cities you have chosen or zip codes you have "added" will appear at the top of this list (see **ADD** below).

Want to learn more about **adding and editing sites**? See page 29.

Time Zone	Shift
Atlantic	-4 Hours
Eastern	-5 Hours
Central	-6 Hours
Mountain	-7 Hours
Pacific	-8 Hours
Alaska	-9 Hours
Hawaii	-10 Hours

**Table 1:** Time Zone Shift. Calculations are for standard time.

**Note:**  
The Download function requires the optional #505 Astrofinder Software and Cable Connector Kit. See the instruction sheet included with the kit for more information on how to download. Also see **OPTIONAL ACCESSORIES**, page 42.

- **Add:** Scroll through the list of Countries/States. Press ENTER when the site you wish to add displays. Then choose the desired city in the same manner. Choose Zip Code to enter your zip code, if you wish. Choose "Custom" if you wish enter the name of an observing site. In this method, you will enter its name, plus its longitude and latitude. See the margin note on page 29 for more information.

**Delete:** Deletes a stored site from the database.

- **Edit:** Edits a selected site, including: the name, latitude, longitude and time zone. Time Zone refers to the Greenwich Mean Time (GMT) time zone shift. Users West of Greenwich, England use "-" hours, East of Greenwich use "+" hours. For the United States, look up the time zone shift in table above.

**NOTE:** AutoStar compensates for daylight savings time, if selected. See "Setup Menu: Daylight Saving," page 26.

**Owner Info** accesses the owner information menu, including:

- **Name:** Users may enter both their first and last names using the Up and Down Arrow keys to cycle through the alphabet. Use the Right and Left Arrow keys to move through the text. Press ENTER when the entry is complete.

- **Address:** Use the Up and Down Arrow keys to enter your street address, city, state and zip code. Press ENTER when the entry is complete.

**Download** transfers information from another AutoStar. During the operation, the warning "Downloading Do Not Turn Off" appears.

**Clone** uploads information from one AutoStar handbox to another. Three options are available:

- **Catalogs:** Sends only user-defined object information, such as new satellite orbits or comet data to another AutoStar handbox.
- **Software:** Sends only the basic AutoStar software. This is useful if one user has downloaded a new version of AutoStar software from the Meade website ([www.meade.com](http://www.meade.com)) and wants to pass this software along to friends.
- **All:** Everything – user-defined information and AutoStar software – is sent to another AutoStar.

**Statistics** provides basic statistical data about AutoStar, including:

- **Characters Free:** Shows how much room is available in user-defined object memory.
- **Version:** Shows the current version of the AutoStar software.

**Reset** completely resets AutoStar. Most values entered into the menus revert to factory defaults. AutoStar requires initialization again after a Reset before proceeding with observations. See **INITIALIZING AUTOSTAR**, page 17.

## ETX TIPS

### Join an Astronomy Club, Attend a Star Party

One of the best ways to increase your knowledge of astronomy is to join an astronomy club. Check your local newspaper, school, library or telescope dealer/store to find out if there's a club in your area.

At club meetings, you will meet other astronomy enthusiasts with whom you will be able to share your discoveries. Clubs are an excellent way to learn more about observing the sky, to find out where the best observing sites are and to compare notes about telescopes, eyepieces, filters, tripods and so forth.

Often, club members are excellent astrophotographers. Not only will you be able to see examples of their art, but you may even be able to pick up some "tricks of the trade" to try out with your ETX telescope. See page 40 for more information about photography with the ETX.

Many groups also hold regularly scheduled Star Parties at which you can check out and observe with many different telescopes and other pieces of astronomical equipment. Magazines such as *Sky & Telescope* and *Astronomy* print schedules for many popular Star Parties around the United States and Canada.

# ADVANCED AUTOSTAR OPERATION

Before trying out the examples in this section, familiarize yourself with the basic operations of AutoStar described earlier in this manual. The following examples assume that you have a basic knowledge of AutoStar and understand how to scroll to a desired menu or menu option and how to enter numbers and text. It also assumes that you have initialized AutoStar and have placed the telescope in the "Home" position (when appropriate).

## Adding Observing Sites

If you plan to observe using AutoStar at different geographic locations, you can store up to six observation sites in AutoStar's memory to help simplify your telescope setup. Perform these procedures using the Site options (Add, Select, Delete, Edit) of the Setup menu.

### To Add a Site to the user-defined site list:

In this example, you will choose a city and add it to the database list. You will then select the site to enable it.

1. Navigate to the "Setup: Site" menu. Press ENTER,
2. Scroll through the options until "Site: Add" displays. Press ENTER.
3. You are given a choice to enter a zip code (press "1") or select a city from the list (press "2"). If you choose "Zip," enter the digits of your zip code and press ENTER.
4. If you choose "City," scroll through the list of countries/states. Press ENTER when the country/state you wish to add displays.
5. Scroll through the list of cities. Press ENTER when the city you wish to select displays. The sites you choose will appear at the top of the Select list (all other available sites will be listed after the sites you have chosen).
6. To choose a site, navigate to "Site: Select." Press ENTER. Scroll through the list of sites. Both Zip Codes and Cities are displayed. When the desired zip code or site displays, press ENTER.

### To Edit a Site:

In this procedure, you will enter a location that is not available in the AutoStar database by editing data of a nearby site. You will edit the location's name, latitude, longitude and the time zone shift. You will then select the site to enable it.

You will need to know the latitude and longitude of your location to perform this procedure. This information is available on most maps.

1. Using the Add option, choose a site on the list that is closest to your observing site and press ENTER so that the site is added to your observing sites list. Choosing a site already on the list (as opposed to using the "Custom" feature) makes it easier to edit, as the "Time Zone" value may not need to be changed.
2. Scroll to "Site: Edit" and press ENTER. "Edit: Name" displays. Press ENTER.
3. The name of the site you have just entered to your list displays; if it does not, scroll to the site.
4. Using the Arrow keys, change the name of the site so that it now reads the name of your observing location. Press ENTER. "Edit: Name" displays again.
5. Press the Scroll Down key and "Edit: Latitude" displays. Press ENTER.
6. Using the Number Keys, enter the latitude of your observing site and then press ENTER. "Edit: Latitude" displays again.
7. Press the Scroll Down key and "Edit: Longitude" displays. Press ENTER.
8. Using the Number Keys, enter the longitude of your observing site and then press ENTER. "Edit: Longitude" displays again.
9. Press the Scroll Down key and "Edit: Time Zone" displays. Press ENTER. (If the site you chose from the list in step 1 has the same Time Zone as the site you are editing, just press ENTER again to go on to the next step.) "Time Zone" refers to the Greenwich Time Zone shift. Users West of Greenwich, use "-" hours (one hour per time zone) and users East of Greenwich use "+" hours. For the United States, look up the shift in **Table 1**, at the left.
10. After entering the shift, press ENTER. "Edit Time Zone" displays.
11. Press MODE. "Site: Edit" displays.
12. Using the Arrow keys, scroll to "Site: Select." The site you have just edited displays. Press ENTER to select the site or press MODE to exit.

**Note:** You may also add a custom site to the list by choosing "Site: Select" and pressing Enter. Scroll down the list until "Custom" displays. Then add the name of your site and press ENTER. Enter the latitude of the site and press ENTER. Enter the longitude of the site. Press ENTER and you have created a custom site entry which you may select at any time from the "Site: Select" list.

Time Zone	Shift
Atlantic	-4 Hours
Eastern	-5 Hours
Central	-6 Hours
Mountain	-7 Hours
Pacific	-8 Hours
Alaska	-9 Hours
Hawaii	-10 Hours

**Table 1:** Time Zone Shift. Calculations are for standard time.

## Using AutoStar to Find Objects Not in the Database

In this procedure, you will enter coordinates of celestial objects that do not appear in any of the AutoStar database lists. You will enter the object's name and R.A. and Dec. coordinates (required information). You may also enter the object's magnitude and size (optional information).

Although AutoStar contains an extensive database of celestial objects (stars, nebulae, planets, etc.) that you can observe, you may eventually want to view objects that are not part of the database. AutoStar provides a feature that allows you to enter an object's R.A and Dec coordinates in the "User: Objects" option of the Object menu and allows automatic slewing of the telescope to the user-entered coordinates.

In order to use this menu option, you first need to look up the R.A and Dec. coordinates of the object or objects you wish to observe. Check out your local library, computer store or bookstore for astronomy books, CD Roms or magazines (such as *Sky & Telescope* or *Astronomy*), to find coordinates of celestial objects. The objects/coordinates you enter become part of your own permanent database, called "User Objects."

### To enter coordinates of an object into the "User: Objects" option of the Object menu:

1. Make sure AutoStar has been initialized and the telescope has been aligned.
2. After the telescope is aligned, "Select Item: Object" displays. (If necessary, use the Scroll keys to scroll through the menus, as previously described, to find this option.) Press ENTER.
3. "Object: Solar System" displays. Keep pressing the Scroll Up key until "Object: User Object" displays and press ENTER.
4. "User Object: Select" displays. Press the Scroll Down key once. "User Object: Add" displays. Press ENTER.
5. "Name" displays on the top line and a blinking cursor on the second line. Use the Arrow keys, as previously described, to enter the name of the object you wish to add to the database. When you are finished, press ENTER.
6. "Right Asc.: 00.00.0" displays. Use the Number keys to enter the digits for the Right Ascension coordinate of your object. When you are finished, press ENTER.
7. "Declination: +00°.00" displays. Use the Number keys to enter the digits for the Declination coordinate of your object. If necessary, use the Scroll Keys to change "+" to "-." When you are finished, press ENTER.
8. AutoStar then prompts you to enter the size of the object. This step is optional. Use the Number keys to enter the size (in arc-minutes), if so desired and press ENTER to go to the next display. If you do not wish to enter this information, simply press ENTER.
9. AutoStar then prompts you to enter the magnitude of the object. This step is also optional. Use the Number keys to enter this information, if so desired and press ENTER to go to the next display. "User Object: Add" displays again.

### To GO TO a user-entered object:

In this procedure, you will choose an object from the User Object list and GO TO the object.

1. With "User Object: Add" displayed, press the Scroll Up key once. "User Object: Select" displays. Press ENTER.
2. Use the Scroll keys (if necessary) to scroll to the desired object. Press ENTER.
3. The name of the object and the Right Ascension and Declination coordinates display.
4. Press GO TO and the telescope slews to the object.

## Observing Satellites

In this procedure, you will prepare your telescope to observe a satellite pass.

1. Navigate to the "Object: Satellite" menu option and press ENTER.
2. Use the Scroll keys to scroll through the list of satellites.

3. Select a satellite from list and press ENTER.
4. "Calculating...." and then "Tracking..." displays. If the satellite is going to make a pass, "Located" displays.
5. Use the Scroll keys to display data about the pass: aos – acquisition of signal and los – loss of signal. If you subtract the aos from the los, you can calculate how long the satellite will be visible. Location information also displays.
6. "Alarm" displays after the location information. Press ENTER and AutoStar automatically sets the alarm to sound a minute before the satellite's scheduled appearance. You may return to regular observations until the alarm goes off.
7. When the alarm goes off, return to the Satellite menu and press a Scroll key until the desired satellite is on the top line of the display.
8. Press GO TO. AutoStar slews the telescope to where the satellite should appear. The motor drive stops and a countdown is displayed.

**NOTE:** *If the scheduled appearance position of the satellite is obstructed (i.e., by a building, tree or hill), press ENTER and AutoStar starts to move the telescope along the expected satellite track. When the track clears the obstruction, press ENTER again to pause the telescope, then continue with this procedure.*

9. With about 20 seconds left on the countdown timer, start watching through the telescope SmartFinder for the satellite to enter the field of view.
10. When the satellite enters the SmartFinder field of view, press ENTER. The telescope starts to track with the satellite.
11. Use the AutoStar Arrow keys to center the object in the SmartFinder, then look through the eyepiece to view the object.

Satellite orbits change and new satellites (including the Space Shuttle) are launched. Visit the Meade web site ([www.meade.com](http://www.meade.com)) approximately once a month to get updated information and instructions on how to download this data to AutoStar. If orbital parameters are more than one month old, the satellite pass may not happen at the time predicted by AutoStar. Downloading requires the optional #505 AstroFinder™ Software and Cable Connector Kit. See **OPTIONAL ACCESSORIES**, page 42.

**Note:** *Satellite observing is an exciting challenge. Most satellites are in low orbit, travelling at approximately 17,500 mph. When visible, they move quickly across the sky and are only in the field of view for a few minutes, requiring AutoStar to slew the telescope rapidly. Best viewing is near Sunrise or Sunset when the sky is still dark. Viewing in the middle of the night can be problematic because the satellite may pass overhead, but not be visible as it is in the Earth's shadow.*

## How to Create Your Own Guided Tour

When a Guided Tour is selected, AutoStar slews your telescope to a predetermined list of objects and displays information about each object, such as type of object, constellation location, R.A. and Dec coordinates and so forth. AutoStar contains a few Guided Tours which are programmed at the factory. But it is also possible for an observer to create a custom Guided Tour.

A tour is basically an ASCII text file that contains a list of directions and descriptions. Each line of a tour is either a comment line, a command line or a description.

### What you will need:

- A PC with text editor or word processing software installed (the tour must be saved as a "text only" or as a "MS-DOS text" file).
- The Meade #505 Cable Connector Kit to download tour information to the AutoStar handbox.

### Tour Modes

The objects chosen for a tour list are selected from AutoStar's database or by entering the object's RA and Dec coordinates. The tour is presented in one of two modes:

**Automatic Mode:** The title of an object appears on the first line and descriptive text scrolls on line 2.

#### Note:

*Meade's AutoStar Suite provides an easy way for an observer to create their own Guided Tour. See **PHOTOGRAPHY WITH MEADE'S AUTOSTAR SUITE**, page 41, and also **OPTIONAL ACCESSORIES**, page 42, for more information.*

*Interactive Mode:* Tour name appears on the first line of the AutoStar display and the name of the object displays on line 2. To display descriptive text in this mode, the user must press ENTER.

#### **Comment Line**

Information in the Tour program that is not displayed, such as authorship, revision history, copyrights, etc. All comments begin with a "/" character in column 1 of the line. For example:

```
    / Extreme Objects  
    / (c) 2000 Meade Instruments Corporation
```

#### **Command Line**

This line contains programming commands, including: R.A. and DEC. coordinates, a title string, a description string and a keyword.

**RA:** Enter the Right Ascension of an object in the following format: HH:MM:SS.

*Eg.,* 18:51:05

**Dec:** Enter the Declination of an object in the following format: DDdMMmSSs.

*Eg.,* -06d16m00s

**Title String:** Text within a title string is displayed as the title of the object. A title string can contain up to 16 characters and must be surrounded by quotation marks. For example. "M64" or "My Favorite Star."

*In Interactive Mode,* the title string appears on line 2 until it is selected with the ENTER key.

*In Automatic Mode* or after Interactive Mode selection, the title string appears on line 1 while the description scrolls across line 2.

**Keywords:** Action to be performed during a tour. AutoStar recognizes the following keywords:

TITLE	TEXT	USER	NGC
IC	SAO	MESSIER	CALDWELL
PLANET	MOON	SATELLITE	ASTEROID
COMET	LUNAR ECLIPSE	METEOR SHOWER	DEEP SKY
CONSTELLATION	STAR	LANDMARK	DEFINE
PICK ONE/PICK END	AUTO SLEW ON/OFF	#END	

**Description String:** Description of an object. Must be surrounded by quotation marks. If the description is longer than one line, each line must end with a quotation mark and a hard return. Begin the next description line with a quotation mark.

If quotation marks are to be displayed in the on-screen description, use two quote marks at the beginning and end of the desired phrase. For example: "The Orion Nebula is considered ""awesome"" by many who view it."

#### **Writing a Tour**

Using the list of commands listed above, a custom tour can be created. Placing the word AUTO SELECT before any of the command lines activates Automatic Mode and, when selected, AutoStar automatically searches and finds the designated object.

The following is a list of command lines, complete with keywords and necessary strings:

TITLE

Title must be the first keyword in your tour after any comment lines and must be 15 characters or less. AutoStar displays this title when "Guided Tour" is selected from the menus.

For example: TITLE "A Star's Life"

TEXT "title string" "description string"

This command allows you to display a text title and description.

USER ra dec "title string" "description string"

This command line allows you to access a specific object with your own description. Enter USER, then the RA and DEC of a desired object and its title and description. Use the format described in the Command Line section.



The following commands specify objects that are already in the AutoStar database. If these commands follow the command AUTO SELECT, the object's title displays on line 1 and its description scrolls across line 2.

Do not add a description string after the following command lines; these commands access objects with existing description in the AutoStar database.

NGC xxxx

Enter NGC followed by the desired New General Catalog number and AutoStar provides the user with a description of the object from its database. For example: NGC 4256

IC xxxx

Enter IC followed by the desired Index Catalog number and AutoStar provides the user with a description of the object from its database. For example: IC 1217

SAO xxxxxx

Enter SAO followed by the desired SAO number and AutoStar provides the user with a description of the object from its database. For example: SAO 30200

Messier xxx

Enter MESSIER followed by the desired Messier number and AutoStar provides the user with a description of the object from its database. For example: M 101

CALDWELL xxx

Enter CALDWELL followed by the Caldwell number and AutoStar provides the user with a description of the object from its database. For example: CALDWELL 17

PLANET "name"

Enter PLANET and then the name of the desired planet in quotes. AutoStar provides the user with a description of the selected planet from its database. For example: PLANET "Pluto"

MOON

This command accesses information about the Moon from the AutoStar database.

SATELLITE "name"

Enter SATELLITE and then the name of the desired satellite in quotes. AutoStar displays information about the satellite from its database. For example: SATELLITE: "Intl Space Strn"

ASTEROID "name"

Enter ASTEROID and then the name of the desired asteroid in quotes. AutoStar displays information about the asteroid from its database. For example: ASTEROID: "Ceres"

COMET "name"

Enter COMET and then the name of the desired comet in quotes. AutoStar displays information about the comet from its database. For example: COMET: "Halley"

LUNAR ECLIPSE

If LUNAR ECLIPSE is part of the tour, AutoStar checks its database every time the tour is activated to see if a lunar eclipse is visible that evening. If no eclipse is visible, this option is skipped and the tour proceeds on to the next object.

METEOR SHOWER

If METEOR SHOWER is part of the tour, AutoStar checks its database every time the tour is activated to see if a meteor shower is visible that evening. If no meteor shower is visible, this option is skipped and the tour proceeds on to the the next object.

DEEP SKY "name"

Enter DEEP SKY followed by the name of the desired object in quotes. For example: DEEP SKY "Small Magellanic Cloud"

CONSTELLATION "name"

Enter CONSTELLATION followed by the name of the desired constellation in quotes. For example: CONSTELLATION "Leo Major"

STAR "name"

Enter STAR followed by the name of the desired star in quotes. For example: STAR "Vega"

LANDMARK az alt "title" "description"

Enter the azimuth (az) for the desired object in the following format: xxxdxxmxxs. For example: 123d27m00s. Then enter the altitude of the desired object in the following format: xdxmxxs. Then enter the title string and description string in quotes. For example:

LANDMARK 123d27m00s 57d20m20s "Landmark 1" "North corner of apartment building"

PICK ONE / PICK END

These two statements are used to surround a list of items that AutoStar can choose from during a tour. AutoStar begins at the top of the PICK ONE list and displays the first object from the list that is above the horizon and ignores the rest.

This statement is useful for developing tours that can be presented year round. For each object type you wish to use to illustrate in your tour, pick 10 to 12 examples spaced across the range of right ascension. Bracket them by the PICK ONE / PICK END statements. One current example displays for the user. For example:

AUTO SELECT TEXT "Globular Cluster" "Globular clusters are huge balls of stars."  
"They contain 50,000 to 100,000 stars and are located on the fringes of our" "galaxy."

PICK ONE

AUTO SELECT MESSIER 13

AUTO SELECT MESSIER 15

AUTO SELECT MESSIER 92

AUTO SELECT MESSIER 4

AUTO SELECT MESSIER 68

AUTO SELECT NGC 1234

AUTO SELECT TEXT "None Available" "I'm sorry. There are no bright globular"  
"clusters visible at this time."

PICK END

AUTO SLEW ON / AUTO SLEW OFF

With AUTO SLEW ON enabled in the tour, AutoStar automatically slews the telescope to objects first before displaying the text description. This feature is useful when designing tours in which observing certain objects is required. For example, an astronomy professor may require his students to observe six objects, four of which AutoStar automatically slews to in a tour. The students would have to manually slew to the last two objects. He would then place AUTO SLEW ON before his first required object and AUTO SLEW OFF after the fourth object.

#END

To end a tour, type the command #END on a separate line at the very end of the tour.

### Downloading Tours

Once a tour is written and stored as an ASCII file (saved either as a "text only" or "MS DOS text" file), load it into AutoStar using the AutoStar Update Utility on your PC. As tours are downloaded into the handbox, AutoStar examines the programming. If it doesn't understand the terminology used within a tour, it flags questionable areas and displays them in a pop-up window on your computer screen. Make the necessary corrections and try to download again. See the instruction sheet with your #505 Cable Connector Kit for more information about downloading data to and interfacing with AutoStar.

### Landmarks

This menu option allows you to define and store terrestrial objects in the Landmark database. First, a landmark needs to be stored in memory using the "Landmark: Add" option. To view a landmark, use the "Landmark: Select" option. Landmarks may also be viewed using the "Landmark Survey" option in the Utilities menu.

### **To Add a landmark to the database:**

In this procedure, you will store the location of terrestrial landmarks in AutoStar's memory.

1. Set the telescope in the home position, if necessary. Note for future reference where the telescope is located and if you have aligned the telescope, which alignment method is used.

**Important Note:** *To use the Landmark function, the telescope must be located and aligned exactly as when the landmark(s) was added to the database.*

2. Display the "Setup: Targets" menu option. Choose "Terrestrial" and press ENTER – "Setup: Targets" displays again. Choosing this option turns off tracking for astronomical objects and is not useful for the viewing of terrestrial objects such as those in the Landmark database. Be sure to change this option back to "Astronomical" when you wish to view celestial objects again.
3. Press MODE once. "Select Item: Setup" displays.
4. Press the Scroll Down key once and "Select Item: Object" displays. Press ENTER. "Object: Solar System" displays.
5. Press the Scroll Up key twice and "Object: Landmarks" displays. Press ENTER. "Landmark: Select" displays.
6. Press the Scroll Down key once. "Landmark: Add" displays. Press ENTER.
7. "Landmark Name" displays. Using Arrow keys, enter a name for the landmark you wish to add to the database. When finished, press ENTER.
8. "Center Landmark. Press Enter" displays. Using only the Arrow keys (do not manually move the telescope), move the telescope to the desired landmark and center the object in the eyepiece. Press ENTER. The object is now stored in memory.
9. "Landmark: Add" displays. If you wish to add more landmarks, repeat steps 5 through 7.

### **To Select a landmark from the database:**

1. Make sure the telescope is located and aligned exactly as when the desired landmark was entered into memory.
2. Display the "Landmark: Select" menu option. Press ENTER.
3. Use the Scroll keys to scroll through the list of objects you have previously entered. When the desired object displays, press ENTER to select the object. Use the Scroll keys to scroll through location information about the object, if desired. Press GO TO to slew the telescope to the landmark.
4. Press MODE to exit.

### **To perform a Landmark Survey**

This procedure allows you to perform a tour of the objects entered in the "Object: Landmark" menu option—note that the Landmark Survey will function only if you have previously entered objects in the Landmark menu.

1. Navigate to "Utilities: Landmark Survey" menu and press ENTER.
2. "Landmark Survey: Slewing..." displays. The telescope moves to the first object on the Survey list and displays the name of the object.
3. Press MODE to pause the Survey. Press ENTER to restart the survey at the first object of the survey.

### **To check on the available amount of memory in AutoStar.**

AutoStar has a limited amount of memory. Once you begin to store Landmarks, User Objects and other bits of information in AutoStar, you will begin to use up memory. This procedure allows you to check on how much memory is still available.

1. Navigate to the "Setup: Statistics" menu option and press ENTER.
2. "Statistics: 37.2K Char. Free" displays. This is the amount of memory that is still available to the user.

## **Identify**

This procedure allows you to use AutoStar to identify objects you have found in the night sky using the Arrow keys. If the object is not in AutoStar's database, AutoStar

displays information about an object in its database that is closest to the one you queried about.

**IMPORTANT NOTE:** For this function to operate properly, you must first set the telescope in the home position and initialize AutoStar. If you physically move the telescope after initialization, this function will fail to operate properly.

In this procedure, you will center an object you wish to have identified by AutoStar in the telescope eyepiece and use the "Identify" menu to find out information about the object or the nearest object to it in the AutoStar database.

1. Center the object you wish to have identified in the telescope's eyepiece.
2. Navigate to the "Object: Identify" option and press ENTER.
3. "Searching..." displays. When AutoStar finishes calculating, the name of the closest object displays.
4. Press a Scroll key to display information about this object. AutoStar displays some or all the following information about the object with each press of a Scroll key:

**Displayed information:**

Catalog or common name of object  
 Type of object  
 Right Ascension  
 Declination  
 Constellation  
 Magnitude  
 Size  
 Scrolling message

**Example:**

Messier 107, NGC6171 orion Nebula, etc  
 Globular Cluster, Nebula, Black Hole, etc.  
 16:32:4  
 13°03'  
 Virgo orion, etc.  
 3  
 2'  
 "This Globular Cluster is 10,000 light years away...."



Fig. 29a [top view]: Rotate the telescope tube counterclockwise until it stops.....



Fig. 29b [top view]: ....then rotate it clockwise a quarter turn.....

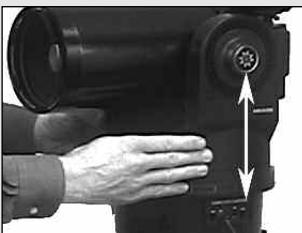

Fig. 29c [side view]: ....until a fork arm is over the computer control panel.

**Advanced Alt/Az Alignment**

If you would rather choose your own alignment stars from the AutoStar database during the Alt/Az alignment procedure, AutoStar offers additional alignment methods. Information for Equatorial (Polar) alignment is discussed in **APPENDIX A**, page 50.

In order to perform either Two-Star, Easy Align or One-Star Alt/az alignment, you will first need to put the telescope in the home position:

- If necessary, tighten the telescope's vertical lock (**6, Fig. 1b**).
- Unlock the horizontal lock (**9, Fig. 1a**). This will allow you to rotate the telescope tube and fork arm assembly.
- Grasp the telescope by a fork arm and rotate the telescope counterclockwise until it stops (**Fig. 29a**).
- Turn the telescope clockwise about a quarter of a turn (**Fig. 29b**). until a fork arm is directly over the computer control panel (**Fig. 29c**).
- Re-lock the horizontal (**9, Fig. 1a**) and vertical locks (**6, Fig. 1b**).

**Two-Star Alt/Az Alignment and Easy Align**

Two-Star Alignment requires some knowledge of the night sky. AutoStar provides a database of bright stars and two stars from this database are chosen by the observer for alignment (Easy Align operates the same as Two-Star Alignment, except that AutoStar picks the two alignment stars from its database).

1. **Perform steps 1 and 2** as described in **AUTOMATIC ALIGNMENT**, page 17.
2. With "Align: Easy" displayed, use the Scroll keys to display "Align: Two Star." Press ENTER. (If you wish to use Easy Align, press ENTER when "Align: Easy" displays.)
3. Place the telescope in the home position as described in the **AUTOMATIC ALIGNMENT** procedure. When you have finished, press ENTER.
4. "Select Star" displays. AutoStar then displays a database of stars for the observer to choose from. Use the Scroll keys to scroll to a star on the list that you wish to align upon. Select a star that you can easily locate in the night sky. Press ENTER.
5. The telescope slews to the star. Use the Arrow keys to move the telescope until the star is centered in the eyepiece. Press ENTER.
6. Repeat procedure for the second alignment star. The telescope is aligned and you are now ready to use AutoStar's GO TO capabilities for a night of observing.

Want to learn more about **Parking your telescope**? See page 26.

### One-Star Alt/Az Alignment

One-Star Alignment requires some knowledge of the night sky. AutoStar provides a database of bright stars. One-Star Alignment is identical to Two-Star Alt/Az: Alignment (see **TWO-STAR ALT/AZ ALIGNMENT**, above), except only one star from this database is chosen by the observer for alignment.

**IMPORTANT NOTE:** *The accuracy of One-Star Alt/Az Alignment, unlike the Two-Star and Easy (Alt/Az) Alignment procedures, depends on how well the observer levels the telescope and how close to North the telescope is pointed when setting the Home Position. Because the other methods use two stars to align upon, they are more precise than One-Star Alignment.*

### Smart Drive Training (Periodic Error Correction)

If you wish to improve the gear performance on your telescope, first, perform the train the drive procedure (see page 55). Then use the Periodic Error Correction (PEC) Train menu option to remove the slight perturbations from center that occur due to the mechanical nature of a telescope. To perform this procedure, you need to use a high-power reticle eyepiece, such as the 9mm reticle (see **OPTIONAL ACCESSORIES**, page 42).

**Important Note:** *In order for the PEC training to operate and be updated properly, you must "park" the telescope to maintain PEC (see **PARK SCOPE**, page 26, for more information).*

#### PEC Train Menu Option

To perform the procedure on the R.A. axis, pick a bright star in the South that has minimal movement and is about 30° above the horizon (**Note:** *If in the Southern hemisphere, pick a star in the North that is about 30° above the horizon*). This procedure takes about 24 minutes for the ETX Premier telescopes.

**Important Note:** *The Train option overwrites any previous PEC data.*

1. Select "PEC Train" from the Smart Drive menu (in the "Setup: Telescope" menu) and press ENTER.

### ETX TIPS

#### Observing Considerations

- Try to pick an observing site away from street and house lights and car headlights. While this is not always possible, the darker the site, the better.
- Give your eyes about ten minutes to adjust to the darkness before observing. Give your eyes a rest from observing every ten or fifteen minutes to relieve eyestrain.
- Try not to use a standard flashlight. Experienced observers use red LED flashlights, the red utility light on the AutoStar handbox or tape red cellophane over their flashlights to use for setup and map reading so they don't have to continually readjust their eyes to the darkness. Be careful not to shine bright lights if there are other observers in the area. Do not shine a flashlight into the telescope while someone is observing!
- Dress warmly. It gets chilly when you're sitting for prolonged periods.
- Practice setting up your equipment during the day or in a lighted area to become familiar with it before going to a dark site.
- Use your 26mm eyepiece to view terrestrial objects and wider areas of space, such as open star clusters. Use optional higher power eyepieces, such as a 9mm eyepiece (see **OPTIONAL ACCESSORIES**, page 42 for more details), when you wish to view something up close, such as craters on the Moon or the rings of Saturn.
- Bring your instructions manual along with you when you observe. Become familiar with its layout, so it will be easier for you to look up information with just a (red) flashlight.
- Invite your friends and family to come and observe with you. But practice locating 3 or 4 objects to show them beforehand; if you have long delays, they will become bored and lose interest. Also, demonstrate how to focus the telescope in a well-lit area before you go to the observing site.

2. Look through the reticle. Use the Arrow keys to keep the star centered in the reticle cross-hairs. AutoStar displays a count of the 150 positions of the worm gear. When the count reaches 150, one cycle is complete. A full cycle takes about 24 minutes.
3. Press MODE to exit.

#### **PEC Update Menu Option**

PEC Update does not overwrite the data, but updates the training using information gathered from both the last and the current training sessions. Press the MODE key to exit from this option. If you wish to further refine your training, select this menu again and repeat the procedure.

#### **PEC Erase Menu Option**

Select this option to erase all PEC training data.

### **Browse**

**This menu** allows you to search the database for objects with certain parameters, much like a search engine. The "Edit Parameters" option lets you set various parameters for the search and "Start Search" activates the search. A typical search might be performed as follows:

1. Select "Browse" from the Object menu. Press ENTER. "Browse: Start Search" displays.
2. Press one of the Scroll Keys and "Browse: Edit Parameters" displays. Press ENTER.
3. "Edit Parameters: Largest (mins)" displays. "Mins" stands for arc-minutes. Press ENTER.
4. "Largest (mins)" and a value displays. Using the Number keys, enter a size in arc-minutes. AutoStar will search for objects *up to* this size and no larger. Press ENTER.
5. "Edit Parameters: Largest (mins)" displays again. Press the Scroll Down key. "Edit Parameters: Smallest (mins)" displays. Enter the value for the smallest size of an object that AutoStar will search for in the database. Continue with "Brightest," "Faintest," and "Minimum Elevation," using the procedure described in steps 3 and 4.
6. After "Minimum Elevation," "Object Type" displays. Press ENTER. "+Black Hole" displays. If you do *not* wish to have "Black Holes" in your search, press ENTER and the "+" changes to a "-." Press the Scroll Down to scroll to the next item. "+Diffuse Nebula" displays. Continue to scroll through the list and press ENTER if you wish to change the "+" to a "-" or vice-versa.
7. After you have scrolled to the last item on the "Object Type" list, press MODE twice and the Scroll Down key once. "Browse: Start Search" displays. Press ENTER. "Start Search: Next" displays. Press ENTER. AutoStar searches the database and displays the first object that matches the search parameters you have entered. Use the scroll keys to display information about the object. Press MODE and "Start Search: Next" displays again. Press ENTER and the next item matching the parameters displays. Repeat this procedure to display all the objects.
8. Press MODE repeatedly to leave this menu.

# PHOTOGRAPHY

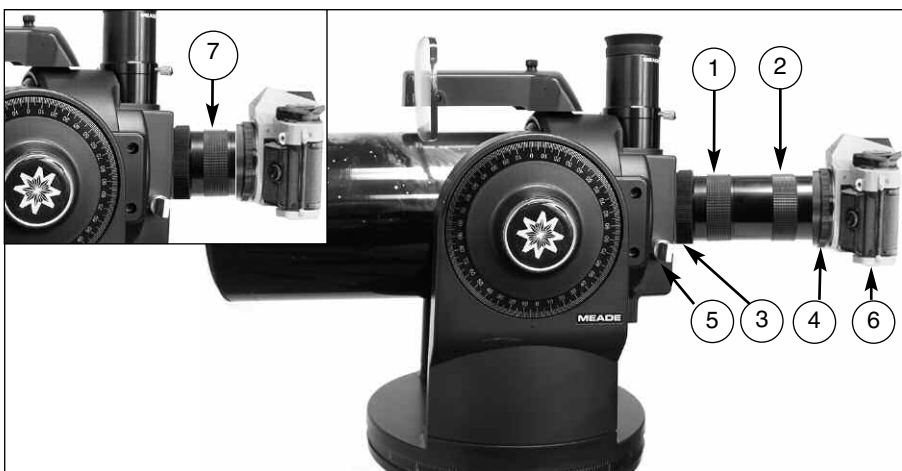

**Fig. 30:** Example of photography through the ETX using the #64 T-Adapter: (1) Short section of #64 T-Adapter; (2) Extension section of #64 T-Adapter; (3) Knurled attachment ring; (4) T-mount; (5) Flip-mirror control in “up” position; (6) 35mm camera body; (7) Format 1.



**Fig. 31a:** Flip mirror control in the “up” position.



**Fig. 31b:** Flip mirror control in the “down” position.



**Fig. 32a:** Example of a format 1 photo.



**Fig. 32b:** Example of a format 2 photo.

## Photography with a 35mm Camera

Photography through your ETX model requires the addition of the optional #64 T-Adapter (see **OPTIONAL ACCESSORIES**, page 42). With the #64 T-Adapter attached to the telescope (**Fig. 30**), through-the-telescope photography is possible with any 35mm camera body with a removable lens. In this way the telescope effectively becomes the lens of the camera.

For through-the-telescope photography, turn the flip-mirror control (**5, Fig. 30**) to the “down” position, allowing light to pass straight through the telescope and out the photo port (**Figs. 31a and 31b**). With the flip-mirror control in the “down” position and the photo port’s dust cover removed, you can see the front lens of the telescope when you look through the photo port. The #64 T-Adapter threads onto the photo port, followed by a T-mount for the particular brand of 35mm camera being used, followed by the camera body (with the camera lens removed).

The #64 T-Adapter consists of two sections (**1 and 2, Fig. 30**), which are threaded together in shipment. You may use either of the following photographic mounting formats to couple the camera body to the telescope’s photo port thread.

- **Format 1: Camera Body + T-Mount + Section (1) of the #64 T-Adapter (7, Fig. 30).**

ETX-90PE	1250mm at f/13.8
ETX-105PE	1640mm at f/15.6
ETX-125PE	1900mm at f/15

Format 1 utilizes only the short section of the #64 T-Adapter to permit close-coupling of a camera body to the telescope. In this format vignetting will occur; the photographic image will appear on film with a slight darkening at the corners of the 35mm frame (see **Fig. 32a**).

- **Format 2: Camera Body + T-Mount + Sections (1) and (2) of the #64 T-Adapter (see Fig. 30).**

ETX-90PE	1450mm at f/16
ETX-105PE	1830mm at f/17.4
ETX-125PE	2310mm at f/18

Format 2 utilizes both sections of the #64 T-Adapter threaded together to form a rigid unit. In this configuration there is no field vignetting; images are illuminated to the edges of a standard 35mm frame (see **Fig. 32b**).

To frame an object in the viewfinder of the 35mm camera body, slightly loosen the knurled attachment ring (**3, Fig. 30**), which threads the #64 T-Adapter to the telescope’s photo port; rotate the camera body to achieve proper framing of the object; then re-tighten the knurled ring.

Photography through a long lens, such as the ETX, requires special technique for good results. The photographer should expect to use several rolls film in acquiring this technique. Long-lens photography has its own rewards, however, which short-focus lenses cannot duplicate.

#### **A Few Tips on Photography**

1. Use the standard tripod or the optional table tripod ( see **OPTIONAL ACCESSORIES**, page 42) as a platform for the telescope. At effective focal lengths of 1250mm to 1450mm (ETX-90PE), 1640mm to 1830mm (ETX-105PE) or 1900mm to 2310mm (ETX-125PE), even small external vibrations can easily ruin an otherwise good photo.

**Caution: With the #64 T-Adapter and a camera body mounted to the ETX photo port, the telescope can be rotated vertically only 45°. Moving past this point may damage the telescope and camera.**

2. Use a cable-operated shutter release with your camera. Touching the camera body to operate the shutter will almost certainly introduce undesirable vibrations.
3. Focus the image with extreme care. While observing the subject through the camera's reflex viewfinder, turn the ETX's focus knob (**8, Fig. 1b**) to achieve the sharpest possible focus. Note that some 35mm cameras may have an optional focusing screen (available from the manufacturer) for use with a long telephoto lens. This screen provides a brighter and clearer image to focus and is highly recommended.
4. Correct shutter speeds vary widely, depending on lighting conditions and film used. Trial-and-error is the best way to determine proper shutter speed in any given application.

**Note:** *The camera used with an ETX model may have an **exposure meter** that is still active when the standard lens is removed and the body is connected to the telescope with the T-mount. If used for terrestrial photography, the camera meter should be acceptable. If used for astrophotography, the meter probably will not provide good results since camera meters are not made to compensate for a dark sky.*

5. Terrestrial photography through an ETX model is sensitive to heat waves rising from the Earth's surface. Long distance photography is best accomplished in the early morning hours before the earth has had time to build up heat.
6. Photography of the Moon and planets through an ETX model can be especially gratifying, but points 1 through 4 should be particularly noted in this case. Lunar or planetary photography requires that the telescope be polar aligned (see **EQUATORIAL (POLAR) ALIGNMENT**, page 50).

**Note:** *Long-exposure photography of deep-sky objects is not practical with an ETX model, since this type of photography requires special electronic and optical guiding devices not available for this telescope.*

#### **Photography with a Digital Camera**

Although digital cameras still cannot match the quality of images provided by traditional 35mm cameras, they provide some significant advantages to the casual astrophotographer: You do not have to develop the images (instant images), lower costs, computer and internet readiness. And because unwanted photos are easily discarded, they provide the freedom to experiment.

Digital cameras present some problems for the astrophotographer: Many models have lenses that cannot be removed, difficulties in attaching to a telescope, possible vignetting, lack manual focusing and shorter exposure times.

Shorter exposure times is one of the biggest drawback. Long exposures with digital cameras introduce undesirable noise and artifacts into a digital image. This limits the range of astro images to the Moon, planets and bright stars.

Some tips for better photos:

- If you cannot remove the lens to your camera, look for a commercially available digital t-adapter. New solutions for attaching a digital camera to a telescope are becoming available as time goes by.



- If the camera is not directly coupled to the eyepiece, keep it as close to the eyepiece as possible and center the image to be photographed to minimize vignetting (darkening of the edges of the photo).
- Try to block ambient light (from street lights, house, etc.) from the eyepiece and the camera with a piece of cardboard, a screen, etc.
- Keep extra (charged) batteries on hand for your camera as digital cameras often drain batteries in a short period of time. Rechargeable Lithium batteries provide power for a longer period than non-rechargeable batteries. If practical, use an AC adapter.
- Avoid short-focus eyepieces. They present many difficulties for digital cameras.
- If using manual focus, set to infinity. Otherwise, using the camera's autofocus is OK.
- Experiment with your camera's exposure, brightness and /or contrast settings. Keep notes for future reference.
- Clean eyepieces and camera lens as needed.
- Many digital cameras have a manual ISO setting. Short exposures times work the best.
- Use your camera's highest image quality and lowest compression settings. Although this fills up your camera's memory more quickly, it produces the best quality photos.
- Use the camera's timer or remote shutter release (if available for your camera) to minimize vibration. Wireless shutter releases may be available for some model digital cameras. If you do not have a shutter release, use the camera's timer (sometimes called "self-timer"), which is available with most digital cameras. The timer may also minimize vibration.



**Fig. 33:** The Deep Sky Imager.



**Fig. 34:** The Lunar Planetary Imager.

### Photography with Meade's AutoStar Suite™

The AutoStar Suite with Meade LPI™ (Lunar Planetary Imager) or Meade Deep Sky Imager™ turns your Meade ETX telescope, AutoStar and PC into even more powerful and easy-to-use astronomical instrument.

LPI (**Fig. 34**) and Deep Sky Imager (**Fig. 33**) combine the power of an electronic astronomical imager with the simplicity of a web cam. Check out the following imager features:

- Achieve great results the first time out on the Moon, planets, brighter deep-sky objects and terrestrial targets.
- Easy to use with real-time display of object on your PC screen. Just center, focus and shoot.
- Magic Eye software-assisted focusing.
- Automatic and manual exposure control from .001 to 15 seconds (up to 450x longer than web cams).
- Automatically takes multiple exposures.

The AutoStar Suite Software includes powerful tools to help you get the most from your Meade ETX telescope:

- Sophisticated planetarium program with over 19 million objects.
- Select objects from the planetarium display and the telescope slews to those objects.
- Create time-lapse movies of objects, such as Jupiter
- Create your own Guided Tours.
- Advanced Image Processing Software including Unsharp Masking, Convolution Filtering and many other features.
- Control all AutoStar functions from your PC.
- Talking Telescope software translates AutoStar text to synthesized speech through PC speaker.
- Includes a cable to connect your ETX model to your PC.

See the CD Rom that is included with AutoStar Suite for more information and instruction manual.

# OPTIONAL ACCESSORIES

A wide assortment of professional Meade accessories are available for the for ETX telescopes. Meade accessories greatly extend many important applications to the telescope, from low-power, wide-field terrestrial viewing to high-power lunar and planetary observing. The premium quality of these accessories is well-suited to the quality of the instrument itself.

Meade telescopes and accessories, including optional accessories for ETX telescopes, are available at more than 3,000 dealer locations in the U.S. and Canada and through Meade international distributors worldwide. Once you have identified the accessories you wish to order, contact your local Meade authorized dealer. To find a dealer near you call (949) 451-1450 or visit the Meade website at [www.meade.com](http://www.meade.com).

**#505 Cable Connector Kit:** With Meade AstroFinder software loaded into your PC, AutoStar-equipped ETX-90PE, ETX-105PE, and ETX-125PE telescopes may be remotely controlled from the PC display. The **#505 Cable Connector Set**, permitting connection of ETX, AutoStar and PC, is included with each AstroFinder package.

**Eyepieces:** For higher and lower magnifications, Meade Super Plössl (SP) and Super Wide Angle (SWA) eyepieces (**Fig. 35**), as well as the Series 4000 8mm to 24mm Zoom eyepiece, yield high-resolution imaging with all ETX telescope models. A useful selection includes the SP 9.7mm, SP 12.4mm and SWA 16mm. Under good seeing conditions, Meade Series 5000 Ultra Wide Angle 4.7mm and 6.7mm eyepieces present the widest obtainable fields of view at high powers and are well suited for observing the Moon and planets (other eyepieces are available in this series). Powers obtained with each eyepiece are shown in the following table.



**Fig. 35:** Optional Eyepieces yield higher and lower magnifying powers.



**Fig. 36:** Use the #126 2x Barlow Lens to double the magnification of the eyepiece employed.



**Fig. 37:** #825 Right-Angle Viewfinder.

Eyepiece	ETX-90PE		ETX-105PE		ETX-125PE	
	Power	2x Barlow	Power	2x Barlow	Power	2x Barlow
SP 6.4mm	195X	390X	230	459	297X	594X**
SP 9.7mm	129X	258X	152	303	196X	392X
SP 12.4mm	101X	202X	119	237	153X	306X
SP 15mm	83X	166X	98	196	127X	253X
SP 20mm	63X	126X	74	147	95X	190X
SP 26mm *	48X	96X	57	113	73X	146X
SP 32mm	39X	78X	46	92	59X	119X
SP 40mm	31X	62X	37	74	48X	96X
SWA 16mm	78X	156X	92	184	119X	238X
SWA 20mm	63X	126X	74	148	106X	211X
SWA 24mm	52X	104X	61	122	79X	158X
UWA 4.7mm	266X	N/A	313	N/A	404X	N/A
UWA 6.7mm	187X	374X **	219	439**	284X	567X**

\* Included as standard-equipment with the ETX models.

\*\* Use these eyepieces only under extremely steady atmospheric conditions.

**#126 2x Barlow Lens:** An amplifying lens, the multi-coated #126 2x Barlow (**Fig. 36**) doubles the power of all eyepieces with which it is used. Insert the #126 into the telescope's eyepiece holder first, followed by an eyepiece. **Example:** By itself, the 26mm eyepiece yields a power of 73X with the ETX-125PE; when used with the #126 2x Barlow Lens, this eyepiece yields 146X.

**#64 T-Adapter:** The basic means of photography through any ETX Astro telescope, the #64 T-Adapter threads to the rear cell of the telescope, followed by a T-Mount appropriate to the user's brand of 35mm camera. In this way, the camera body is rigidly coupled to the telescope's optical system, which in effect becomes the camera's lens (see **PHOTOGRAPHY**, page 38).

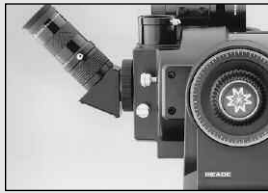

**Fig. 38:** The #932 45° Erecting Prism.



**Fig. 39:** #774 Hard Carrying Case shown with an ETX-90PE.



**Fig. 40:** The #765 Soft Carry Bag for the ETX-90PE.



**Fig. 41:** #1244 Electric Focuser.



**Fig. 42:** Meade Deep Sky Imager

**#932 45° Erecting Prism:** All ETX models include an internal optically-flat mirror to reflect light to the telescope's 90° astronomical observing position. In this position the telescope's image is upright, but reversed. For terrestrial observing with an ETX model, the #932 Erecting Prism (**Fig. 38**) correctly orients the eyepiece image and provides a convenient 45° observing angle.

**#774 Hard Carrying Case** (for the ETX-90PE), **#776 Hard Carrying Case** (for the ETX-105PE) and **#775 Hard Carrying Case** (for the ETX-125PE): For secure portability of ETX Astro Telescope models in the field, Meade hard carrying cases (**Fig. 39**) are fully lined with fitted foam inserts. They accept the complete ETX Astro Telescope plus optional accessories.

**#765 Soft Carry Bag:** The Meade soft-padded carry bag (**Fig. 40**) is well suited to travel with the ETX-90PE Astro Telescope. Each carry bag includes a shoulder strap and permits ready transport of the complete telescope, including accessories.

**Power Adapters and Cords:** In addition to their internal battery packs, ETX-90PE, ETX-105PE, and ETX-125PE telescopes may be powered from standard 115vAC home electricity with the **#541 AC Adapter**. The #541 plugs into any standard home outlet and includes a 25 ft. cord connecting to the telescope's control panel. Input voltage to the telescope is 12vDC. Alternately, an ETX telescope may be powered in the field from an automobile cigarette lighter plug by using the **#607 Power Cord**, a 25-ft. cord that plugs into the telescope's control panel and supplies 12vDC directly from the car battery.

**#1244 Electric Focuser (for the ETX-90PE and ETX-105PE) and #1247 Electric Focuser (ETX-125PE):** Meade-engineered for smooth, rapid focusing with any ETX model, each electric focuser (**Fig. 41**) includes coarse and micro-fine speeds. The standard-equipment hand controller accepts one (user-supplied) 9-volt battery and focuses the ETX telescope. On the ETX models, the focuser plugs into and is powered by, the telescope's control panel, with operation effected through either the AutoStar or the optional #497 AutoStar Computer Controller.

**#887 Advanced Field Tripod for the ETX-105PE or ETX-125PE:** For extra stability in sensitive applications of the ETX-105PE or the ETX-125PE even at the highest magnifications, the fixed height #887 Tripod permits either altazimuth or equatorial orientation of the telescope for astronomical or terrestrial observing. The #887 includes an equatorial wedge for polar alignment. The tripod's 2"-diameter steel legs collapse for easy transport in the field.

**Series 4000 Plössl 9mm Illuminated Reticle Eyepiece:** The most advanced commercially-available illuminated reticle eyepiece, this Series 4000 Plössl 9mm model, powered by an internal battery, includes micrometric x-y positioning controls which greatly facilitate locking onto the guide star: Turn the finely-threaded controls and place the reticle's crossline pattern precisely at the desired position in the field. The sharp, high-power imaging of the 4-element, multi-coated Plössl optical system is complemented by a rubber eyecup (foldable for eyeglass wearers) that shuts out distracting stray light from the observer's eye. The upper (lens) section of the eyepiece rotates on a fine thread for precise diopter adjustment to the user's eye. Reticle pattern is a double crossline with two concentric circles.

**Deep Sky Imager:** This high-performance, easy-to-use and affordable color CCD camera (**Fig. 42**) suppresses electronic noise and does not compress data from the sensor to increase picture quality. The Deep Sky Imager uses a full 16-bit analog-to-digital converter to enhance picture depth, contrast and dynamic range. It is USB compatible for easy interface with most Windows-based laptop computers. Includes AutoStar Suite which automatically sorts, aligns and combines the best images, resulting in a highly detailed color image.

**Atomic Time Update Module:** For use with all Meade ETX Premier Edition telescopes, this optional accessory allows you update the LNT Module with the time signal from the NIST atomic clock in Fort Collins, Colorado.

# MAINTENANCE

Your ETX model telescope is a precision optical instrument designed to yield a lifetime of rewarding observations. Given the care and respect due any precision instrument, the telescope will rarely require factory servicing or maintenance. Use the following guidelines:

1. Avoid cleaning the telescope's optics: a little dust on the front surface of the telescope's correcting lens causes virtually no degradation of image quality and should not be considered reason to clean the lens.
2. When absolutely necessary, remove dust from the front lens with gentle strokes of a camel-hair brush or blow it off with an ear syringe (available at any pharmacy). *Do not use a commercial photographic lens cleaner.*
3. You may remove organic materials (*e.g.*, fingerprints) from the front lens with a solution of 3 parts distilled water to 1 part isopropyl alcohol. A single drop of biodegradable dishwashing soap may be added per pint of solution. Use soft, white facial tissues and make short, gentle strokes. Change tissues often.

**Caution:** *Do not use scented, colored or lotioned tissues or damage could result to the optics.*

4. In the very rare situation where cleaning the inside surface of the corrector lens becomes necessary, unthread the lens cell located at the front of the main tube. The entire correcting lens and secondary mirror system are mounted in this cell. You may use the lens-cleaner solution described in step 3 to clean the inside surface of the lens.

**Caution:** *Do not touch the aluminized circular surface of the secondary mirror with a finger, a tissue or any other object. This will almost certainly scratch the mirror surface.*

**Note:** *When cleaning the inside surface of the correcting lens, leave the lens mounted in its metal cell throughout the process. Do not remove the lens from its metal housing or optical alignment of the lens will be lost, necessitating a return of the telescope to the Meade factory.*

5. If your ETX model is used outdoors on a humid night, telescope surfaces may accumulate water condensation. While such condensation does not normally cause any damage to the telescope, it is recommended that the entire telescope be wiped down with a dry cloth before being packed away. *Do not, however, wipe any of the optical surfaces.* Rather, simply allow the telescope to sit for some time in warm indoor air, so that the wet optical surfaces can dry unattended. In addition, the dust cap should not be placed back on to the optical tube until the telescope is thoroughly dry.
6. If your ETX model is not to be used for an extended period, perhaps for one month or more, it is advisable to remove the eight AA-size batteries from inside the drive base. Batteries left installed for prolonged periods may leak, causing damage to the telescope's electronic circuitry (see **HOW TO ASSEMBLE YOUR TELESCOPE AND TRIPOD**, page 12).
7. The super-gloss anodized finish of any ETX model's deep-violet optical tube fades if left in direct sunlight for prolonged periods.
8. Do not leave your ETX model outdoors on a warm day or inside a sealed car for an extended period of time; excessive ambient temperatures can damage the telescope's internal lubrication and electronic circuitry.
9. A (English-format) hex wrench is provided with ETX models. This wrench is used as follows:
  - Small wrench (.05"): Use the small wrench to tighten the set-screws of any knobs that may loosen (*e.g.*, the focus knob or flip-mirror control knob).

## Storage and Transport

When the telescope is not in use, store it in a cool, dry place. Do not expose the instrument to excessive heat or moisture. It is best to store the telescope in its original box with the vertical and horizontal locks (**6 and 9, Fig. 1a and 1b**) in the *unlocked* positions. If shipping the telescope, use the original box and packing material to protect the telescope during shipment.

When transporting the telescope, take care not to bump or drop the instrument; this type of abuse can damage the optical tube and/or the objective lens and knock the optics out of alignment. It is highly recommended to use an optional carry case to transport the telescope (see **OPTIONAL ACCESSORIES**, page 42).

## Inspecting the Optics

A few words about the so-called “Flashlight Test:” If a flashlight or other high-intensity light source is pointed down the main telescope tube, the view (depending upon the observer’s line of sight and the angle of the light) may reveal what appear to be scratches, dark or bright spots or uneven coatings, giving the appearance of poor quality optics. These effects are only seen when a high intensity light is transmitted through lenses or reflected off the mirrors and can be seen on any high-quality optical system, including giant research telescopes.

The optical quality of a telescope cannot be judged by the “flashlight” test; the true test of optical quality can only be conducted through careful star testing.

## Troubleshooting

The following suggestions may be helpful with operation of the ETX-90PE, ETX-105PE and ETX-125PE.

### ***The power indicator light on the telescope does not come on or there is no response when pressing the AutoStar Arrow keys:***

- Verify that the Computer Control panel power switch (**A, Fig. 2**) is in the ON position.
- Verify that the AutoStar coil cord is firmly connected to the HBX port (**C, Fig. 2**).
- If using internal power (batteries), verify that the batteries are installed correctly and that they have sufficient charge (see **HOW TO ASSEMBLE YOUR TELESCOPE AND TRIPOD**, page 12).

**Note:** *If the batteries are getting low on charge, there will be a marked difference in the slew speed. The speed indicator lights may also flash and the speed may change. If any of these symptoms occurs, turn the power off and replace the batteries.*

- If using an external power source, verify that it is properly connected between the 12-volt connector (**D, Fig. 3**) and either a wall plug (AC source) or a car cigarette lighter (DC source).
- If AutoStar does not respond to commands, move the power switch to OFF and then back to ON.
- If the telescope does not slew after power is applied or if the motor quits or stalls, verify that there are no physical obstructions that would impede telescope movement.
- If all physical obstacles are removed and the telescope still does not move properly, turn off the power and unplug AutoStar. Plug AutoStar back in and turn the power back on.

### ***Unable to see an image through the eyepiece:***

- Confirm that the lens cover has been removed from the telescope.
- Confirm that the flip-mirror control (**14, Fig. 1b**) is in the “up” position if using the eyepiece holder (**4, Fig. 1b**) so that light is directed to the eyepiece (**1, Fig. 1a**). Confirm that the flip-mirror control is in the “down” position if using the #932 Erecting Prism or doing photography with an ETX model (see **TELESCOPE FEATURES**, page 6 and **PHOTOGRAPHY**, page 38).

***Object appears in the SmartFinder but not in the eyepiece:***

- The SmartFinder is not properly aligned with the telescope (see **ALIGNING SMARTFINDER**, page 13).

***Slew speed does not change when you press the SPEED key or the telescope moves slowly even though the fast slew speed is chosen:***

- The battery power may be low (see **HOW TO ASSEMBLE**, page 12).

***Telescope does not track a celestial object:***

- Make sure that the telescope is correctly aligned. See **AUTOMATIC ALIGNMENT**, page 17, for more information.

***Images through the eyepiece appear unfocused or distorted:***

- The magnification may be too high for the viewing conditions. Back off to a lower power eyepiece (see **CHOOSING AN EYEPIECE**, page 14).
- If inside a warm house or building, move outside. Interior air conditions may distort terrestrial or celestial images, making it difficult, if not impossible, to obtain a sharp focus. For optimal viewing, use the telescope outside in the open air instead of observing through an open or closed window or screen.
- If viewing a land object on a warm day, heat waves will distort the image (see **TERRESTRIAL OBSERVING**, page 15).
- For clear viewing of objects, turn the focus knob (**8, Fig. 1b**) slowly since the “in-focus” point of a telescope is precise. Turning the focus knob too quickly may cause the focus point to pass without notice.
- The optics within the telescope need time to adjust to the outside ambient temperature to provide the sharpest image. To cool down the optics, set the telescope outside for 10 to 15 minutes before observing begins.

***Telescope moves off a terrestrial object while observing:***

- Verify that the vertical and horizontal locks are tight (see **TELESCOPE FEATURES**, page 6).

***Telescope does not move past a certain point:***

- The built-in vertical or horizontal rotational “stops” may have been reached. See **#6**, page 7.

***Telescope pauses when changing slew direction:***

- This pause is normal.

***A terrestrial object appears reversed left-for-right:***

- An eyepiece in the standard 90° observing position (**4, Fig. 1b**) reverses an object left-for-right: To view a correctly oriented image requires the optional #932 Erecting Prism (see **OPTIONAL ACCESSORIES**, page 42).

**Meade Customer Service**

If you have a question concerning your ETX model, call the Meade Instruments Customer Service Department at (949) 451-1450. Customer Service hours are 7:00 AM to 6:00 PM, Pacific Time, Monday through Friday. In the unlikely event that the ETX requires factory servicing or repairs, *write or call the Meade Customer Service Department first, before returning the telescope to the factory*, giving full particulars as to the nature of the problem, as well as your name, address and daytime telephone number. The great majority of servicing issues can be resolved by telephone, avoiding return of the telescope to the factory.

# SPECIFICATIONS

## Specifications: ETX-90PE Astro Telescope

Optical design	Maksutov-Cassegrain
Primary mirror diameter	96mm (3.78")
Clear aperture	90mm (3.5")
Focal length	1250mm
Focal ratio (photographic speed)	f/13.8
Near focus (approx)	11.5 ft (3.5m)
Resolving power	1.3 arc secs
Super multi-coatings (EMC)	standard
Limiting visual stellar magnitude (approx.)	11.7
Image scale	1.16°/inch
Maximum practical visual power	325X
Optical tube dimensions	
(dia. x length)	10.4cm x 27.9cm (4.1" x 11")
Secondary mirror obstruction (dia.; %)	27.9mm (1.1"); 9.6%
Telescope mounting	fork type; double tine
Setting circle diameters	Dec.: 3.5"; R.A.: 7"
SmartFinder	Red dot projected onto finder's lens
LNT Module	High accuracy, temperature-compensated oscillator, updatable using Meade's optional ATUM accessory
Input voltage	12 volts DC
Motor Drive System	DC servo motors with encoders, both axes
Bearings:	
Altitude	UHMW polyethylene
Azimuth	PTFE
Materials:	
Tube body	aluminum
Mounting	high-impact ABS, aluminum-reinforced
Primary mirror	Pyrex® glass
Correcting lens	BK7 optical glass, Grade-A
Telescope dimensions:	
	38cm x 18cm x 22cm (15" x 7" x 9")
Telescope net weight:	
(incl. AutoStar & batteries)	3.5kg (7.8 lbs)
Telescope shipping weight	5.8kg (12.8 lbs)
Battery Life (approx.):	
with AutoStar	20 hrs

## Specifications: ETX-105PE Astro Telescope

Optical design	Maksutov-Cassegrain
Primary mirror diameter	116mm (4.56")
Clear aperture	105mm (4.13")
Focal length	1470mm (57.8")
Focal ratio (photographic speed)	f/14
Near focus (approx)	4.6m (15 ft)
Resolving power	1.1 arc secs
Super multi-coatings (EMC)	standard
Limiting visual stellar magnitude (approx.)	12.1
Image scale	0.99°/inch
Maximum practical visual power	420x
Optical tube dimensions	
(dia. x length)	12.4cm x 32.8cm (4.88" x 12.9")
Secondary mirror obstruction (dia.; %)	3.3cm (1.32"); 9.4%
Telescope mounting	fork type; double tine
Setting circle diameters	Dec.: 3.81"; R.A.: 7.8"

SmartFinder . . . . . Red dot projected onto finder's lens  
 LNT Module . . . . . High accuracy, temperature-compensated  
 . . . . . oscillator, updatable using Meade's  
 . . . . . optional ATUM accessory  
 Input voltage . . . . . 12 volts DC  
 Motor Drive System . . . DC servo motors with encoders, both axes  
 Bearings:  
 Altitude . . . . . ball bearings  
 Azimuth . . . . . PTFE thrust bearing and radial ball bearing  
 Materials:  
 Tube body . . . . . aluminum  
 Mounting . . . . . ABS, with internal aluminum structure  
 Primary mirror . . . . . Pyrex® glass  
 Correcting lens . . . . . BK7 optical glass, Grade-A  
 Telescope dimensions:  
 . . . . . 43cm x 25cm x 20cm (17" x 10" x 8")  
 Telescope net weight:  
 (incl. AutoStar & batteries) . . . . . 6.1kg (13.5 lbs)  
 Telescope shipping weight . . . . . 8.3kg (18.4 lbs)  
 Battery Life (approx.):  
 with AutoStar . . . . . 20 hrs

**Specifications: ETX-125PE Astro Telescope**

Optical design . . . . . Maksutov-Cassegrain  
 Primary mirror diameter . . . . . 138mm (5.43")  
 Clear aperture . . . . . 127mm (5.0")  
 Focal length . . . . . 1900mm (74.8")  
 Focal ratio (photographic speed) . . . . . f/15  
 Near focus (approx) . . . . . 4.6m (15 ft)  
 Resolving power . . . . . 0.9 arc secs  
 Super multi-coatings (EMC) . . . . . standard  
 Limiting visual stellar magnitude (approx.) . . . . . 12.5  
 Image scale . . . . . 0.76°/inch  
 Maximum practical visual power . . . . . 500X  
 Optical tube dimensions  
 (dia. x length) . . . . . 14.6cm x 36cm (5.75" x 14.2")  
 SmartFinder . . . . . 8 x 25mm right-angle  
 Secondary mirror obstruction (dia.; %) . . 39.4mm (1.6"); 9.6%  
 Telescope mounting . . . . . fork type; double tine  
 Setting circle diameters . . . . . Dec.: 4.3"; R.A.: 9"  
 SmartFinder . . . . . Red dot projected onto finder's lens  
 LNT Module . . . . . High accuracy, temperature-compensated  
 . . . . . oscillator, updatable using Meade's  
 . . . . . optional ATUM accessory  
 Input voltage . . . . . 12 volts DC  
 Motor Drive System . . . DC servo motors with encoders, both axes  
 Bearings:  
 Altitude . . . . . ball bearings  
 Azimuth . . . . . ball bearings  
 Materials:  
 Tube body . . . . . aluminum  
 Mounting . . . . . ABS, with internal aluminum structure  
 Primary mirror . . . . . Pyrex® glass  
 Correcting lens . . . . . BK7 optical glass, Grade-A  
 Telescope dimensions:  
 . . . . . 48cm x 23cm x 27cm (19" x 8.9" x 10.8")  
 Telescope net weight:  
 (incl. AutoStar & batteries) . . . . . 6.9kg (15.2 lbs)  
 Telescope shipping weight . . . . . 11.4kg (25.2 lbs)  
 Battery Life (approx.):  
 with AutoStar . . . . . 20 hrs



### AutoStar Specifications

Processor .....	68HC11, 8MHz
Flash Memory .....	1MB, reloadable
Keypad .....	20 key alphanumeric
Display .....	2 line, 16 character LCD
Backlight.....	Red LED
Utility Light .....	Yes
RS-232 .....	Yes
Coil Cord .....	24"
Database .....	30,223 objects

### AutoStar Dimensions

Length .....	6.56" (16.6cm)
Width (LCD end) .....	3.19" (80cm)
Width (Connector end).....	2.25" (57cm)
Depth .....	0.81" (21cm)
AutoStar net weight .....	1.12 lbs (0.51kg)

### ETX TIPS

#### Surf the Web

One of the most exciting resources for astronomy is the internet. The internet is full of websites with new images, discoveries and the latest astronomical information. *For example:* When Mars made its closest approach in 60,000 years to our Sun in 2003, astronomers around the world posted new photos daily.

On the internet, you can find websites for almost any topic relating to astronomy. Try the following key word searches: NASA, Hubble, HST, astronomy, Messier, satellite, nebula, black hole, variable stars, etc.

Check Meade's website for the latest product and technical information. You can download the latest software revisions, links to other astronomical sites, coordinates of celestial objects and the latest satellite tracking information for your AutoStar handbook. See page 30 for more information. You'll find our website at:

[www.meade.com/](http://www.meade.com/)

Here are some other sites you might find interesting:

- *Sky & Telescope:*  
<http://www.SkyandTelescope.com>
- *Astronomy:*  
<http://www.astronomy.com>
- *The Starfield:*  
<http://users.nac.net/gburke/>
- *Astronomy Picture of the Day:*  
<http://antwrp.gsfc.nasa.gov/apod>
- *Heavens Above (satellite observing information):*  
<http://www.heavens-above.com>
- *Photographic Atlas of the Moon:*  
[http://www.lpi.ursa.edu/research/lunar\\_orbiter](http://www.lpi.ursa.edu/research/lunar_orbiter)
- *Hubble Space Telescope Public Pictures*  
<http://opposite.stsci.edu/pubinfo/pictures.html>

# APPENDIX A: EQUATORIAL (POLAR) ALIGNMENT

## Equatorial Alignment

In equatorial (or "polar") Alignment, the telescope is oriented so that the horizontal and vertical axes of the telescope are lined up with the celestial coordinate system.

In order to equatorially align your telescope, it is essential to have an understanding of how and where to locate celestial objects as they move across the sky. This section provides a basic introduction to the terminology of equatorially-aligned astronomy and includes instructions for finding the celestial pole and for finding objects in the night sky using Declination and Right Ascension.

## Celestial Coordinates

A celestial coordinate system was created that maps an *imaginary sphere* surrounding the Earth upon which all stars appear to be placed. This mapping system is similar to the system of latitude and longitude on Earth surface maps.

In mapping the surface of the Earth, lines of longitude are drawn between the North and South Poles and lines of latitude are drawn in an East-West direction, parallel to the Earth's equator. Similarly, imaginary lines have been drawn to form a latitude and longitude grid for the celestial sphere. These lines are known as **Right Ascension** and **Declination**.

The celestial map also contains two poles and an equator just like a map of the Earth. The poles of this coordinate system are defined as those two points where the Earth's North and South poles (*i.e.*, the Earth's axis), if extended to infinity, would cross the celestial sphere. Thus, the North Celestial Pole (**1, Fig. 43**) is that point in the sky where an extension of the North Pole intersects the celestial sphere. The North Star, Polaris, is located very near the North Celestial Pole (**1, Fig. 43**). The celestial equator (**2, Fig. 43**) is a projection of the Earth's equator onto the celestial sphere.

So just as an object's position on the Earth's surface can be located by its latitude and longitude, celestial objects may also be located using Right Ascension and Declination. *For example:* You could locate Los Angeles, California, by its latitude (+34°) and longitude (118°). Similarly, you could locate the Ring Nebula (M57) by its Right Ascension (18hr) and its Declination (+33°).

- **Right Ascension (R.A.):** This celestial version of longitude is measured in units of hours (hr), minutes (min) and seconds (sec) on a 24-hour "clock" (similar to how Earth's time zones are determined by longitude lines). The "zero" line was arbitrarily chosen to pass through the constellation Pegasus, a sort of cosmic Greenwich meridian. R.A. coordinates range from 0hr 0min 0sec to 23hr 59min 59sec. There are 24 primary lines of R.A., located at 15-degree intervals along the celestial equator. Objects located further and further East of the zero R.A. grid line (0hr 0min 0sec) carry higher R.A. coordinates.

- **Declination (Dec.):** This celestial version of latitude is measured in degrees, arc-minutes and arc-seconds (*e.g.*, 15° 27' 33"). Dec. locations North of the celestial equator are indicated with a plus (+) sign (*e.g.*, the Dec. of the North celestial pole is +90°). Dec. locations South of the celestial equator are indicated with a minus (-) sign (*e.g.*, the Dec. of the South celestial pole is -90°). Any point on the celestial equator (such as the the constellations of Orion, Virgo and Aquarius) is said to have a Declination of zero, shown as 0° 0' 0."

### Polar Mounting your Telescope with the #884 Deluxe Field Tripod

As the Earth rotates on its axis, astronomical objects appear to move across the sky in an arc. This apparent motion is not obvious to the unaided eye, but when viewed through a telescope such as an ETX, this motion is rapid indeed. If the motor drive has not been engaged, celestial objects viewed in the telescope eyepiece drift entirely out of the field of view in 15 to 60 seconds, depending on the magnification employed.

However, by mounting your telescope and turning on the motor drive, you can counteract the drift of objects in the eyepiece. The two basic types of mounting are: altazimuth (alt/az) and equatorial. For many ETX owners, it will not be necessary to equatorially mount the telescope; alt/az mounting will suffice. The AutoStar Controller allows the telescope to be mounted in the altazimuth (alt/az) mode for most observing purposes. See **AUTOMATIC ALIGNMENT**, page 17, for more information.

### Important Note:

The "Telescope: Mount" option of the Setup menu is set to "Alt/Az" as the default mount by the factory. If the telescope is equatorially mounted, you must choose the "Polar" option from the AutoStar "Telescope: Mount" menu.

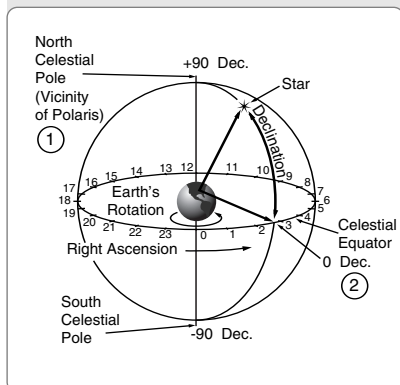
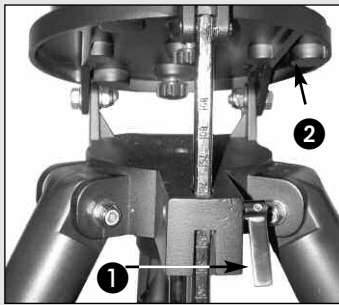
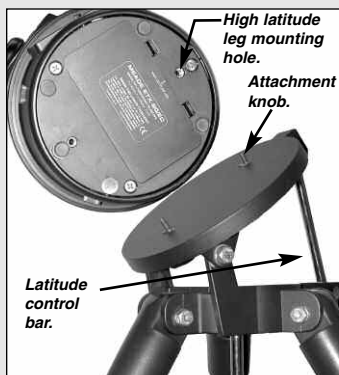

Fig. 43: Celestial Sphere.



**Fig. 44:** Loosen control latch.



**Fig. 45:** High latitude leg mounting hole and corresponding attachment knob.

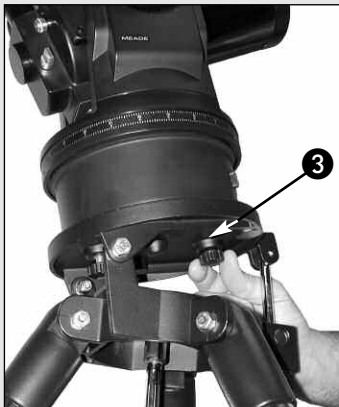

**Fig. 46:** Attach telescope to tripod.

However, owners who wish to perform astrophotography or use the Meade LPI or Deep Sky Imager (see **PHOTOGRAPHY WITH MEADE'S AUTOSTAR SUITE**, page 41, for more information) will find equatorial mounting indispensable to their needs.

### Equatorial Mount

Equatorial mounting lines up the telescope's polar axis with the North Celestial Pole (or the South Celestial Pole if observing in the southern hemisphere).

When using an equatorially mounted telescope, tracking (following) celestial objects is possible by turning on your ETX telescope's motor drive. The motor counteracts the Earth's rotation and keeps objects in the field of view of the eyepiece for hands-off tracking.

### Equatorial Mounting Procedure

1. Assemble the tripod as described in **Step #2** of **How to Assemble Your Telescope and Tripod**, page 12.
2. Loosen the latitude control latch (1, **Fig. 44**) and lift up the tilt-plate (2, **Fig. 44**) so that you can easily access the underside of the plate. Relock the latitude control latch, so the assembly doesn't slip while you are attaching the telescope.
3. Turn the tripod, so that the face of the tilt-plate points North (**Figs. 48 and 49, on next page**). If you attach the telescope to the tripod indoors, be sure to orient the face of the tilt-plate to point North after moving the telescope outdoors. Equivalently, point the tripod leg (5, **Fig. 48**) North. This is the leg *opposite* from the latitude control bar (4, **Fig. 48**).
4. Line up the mounting hole on the base of the telescope labeled "High Latitude Leg" with the attachment knob that is closest to the latitude control bar (see **Fig. 45**). Line up the other mounting hole with the remaining attachment knob. Thread both attachment knobs into the base of the telescope. Tighten to a firm-feel only.
5. Determine the latitude of your observing location from a road map, atlas or the **LATITUDE CHART FOR MAJOR CITIES OF THE WORLD**, page 54. Loosen the latitude control latch (1, **Fig. 47, on next page**) and adjust the latitude control bar (4, **Fig. 47**) so that your observing site's latitude is just visible above the flat surface of the tripod head. Retighten the latch.
6. If you have not already done so orient the tripod leg (see **Step #3** and 5, **Fig. 48**) so that it is pointing due North (if the location of Polaris, the North Star, is known, point the telescope directly at Polaris. Observers located in the Earth's Southern Hemisphere must point the telescope due South).
7. The telescope is now equatorially mounted; the tripod must not be moved or else the alignment will be lost. Instead, use one of the following methods to move the telescope's optical tube to a desired celestial object.
  - (a) Loosen the vertical and/or horizontal locks (6 and 9, **Fig. 1a and 1b**) to permit the optical tube to be freely moved manually. Tighten the locks once you center on the object.
  - (b) With the horizontal and vertical locks in their "locked" positions, use the Arrow keys to move the optical tube.

**Note:** For most astronomical observing requirements, approximate settings of the telescope's latitude and North-pointing tripod leg (**Steps #5 and #6**) are acceptable. Do not allow undue attention to precise equatorial mounting of the telescope to interfere with your enjoyment of the instrument.

### Using an Equatorially Mounted Telescope

Once your telescope is equatorially mounted, the telescope motor drive will keep a celestial object in the telescope eyepiece's field of view.

#### To Track a Star When Polar Mounted:

Make sure you have initialized your telescope before you try out this feature (see **INITIALIZING AUTOSTAR**, page 17).

1. Tighten the vertical and horizontal locks (6 and 9, **Fig. 1a and 1b**) if necessary.
2. Make sure that AutoStar is connected to the HBX port (C, **Fig. 2**) of the telescope's computer control panel.
3. Flip the telescope power switch (A, **Fig. 2**) to the ON position.  
The AutoStar screen displays a copyright message displays, followed by a short beep. Then AutoStar takes a few moments to start up the system.
4. A message displays that warns not to look at the Sun. At the end of this message, press the key prompted by AutoStar to signify that the message has been read and understood.

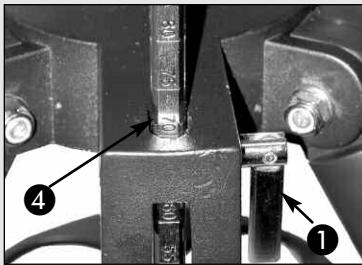

**Fig. 47:** Set latitude.

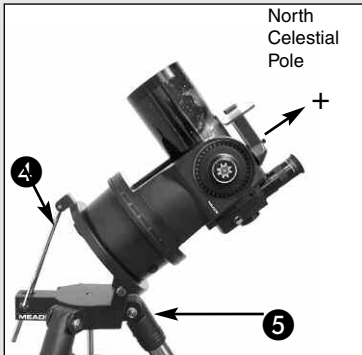

**Fig. 48:** Example of Polar Alignment. Note that the face of the tilt-plate points North.

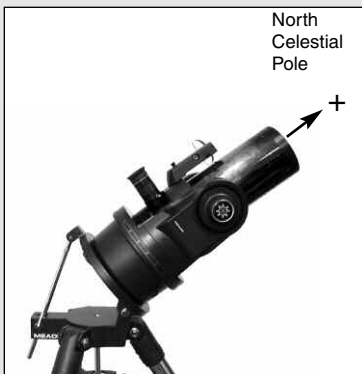

**Fig. 49:** Example of Polar Alignment. Note that the face of the tilt-plate points North. This is the Polar home position.

**Important Note:**  
In order to select any of three polar alignment options, you must first select "Polar" in the "Mount" option of the "Setup: Telescope" menu.

5. Press ENTER repeatedly until "Setup: Align" displays.
6. Press the Scroll Down key repeatedly until "Setup: Telescope" displays. Press ENTER. "Telescope: Telescope Model" displays.
7. Press the Scroll Down key repeatedly until "Telescope: Mount" displays. Press ENTER. "Scope Mounting: Alt/az" displays.
8. Press the Scroll Down key once. "Scope Mounting: Alt/az" displays. Press ENTER. "Telescope: Mount" displays again.
9. Press Mode once. "Setup: Telescope" displays.
10. Press the Scroll Down key once. "Setup: Targets" displays.
11. Press ENTER. "Targets: Terrestrial" displays. Press one of the Scroll keys once. "Targets: Astronomical" now displays.
12. Use the Arrow keys to locate a bright star in the night sky. Use the SmartFinder (2, Fig. 1) to help line up on the star. You may choose any unobstructed, bright star for the purposes of this example. Use AutoStar's Arrow keys to center the star in the eyepiece. Once the star is centered, press ENTER to select "Astronomical." The telescope's tracking motors then engage. It may take the tracking motors several seconds to begin tracking. When they do, it may be necessary to once again center the star in the eyepiece. The tracking motors will then keep the star you have chosen in the center of the eyepiece.
13. Press and hold the ENTER key for a few seconds and then release to stop tracking. You may repeat the procedure to locate another star or object using the Arrow keys. Then press ENTER to re-engage the tracking motors.

**Caution:** Do not move the tripod or adjust the latitude setting while observing or the mounting alignment will be lost. The telescope's motor drive dis-engages when the Horizontal and the Vertical lock levers are unlocked and re-engages when the levers are relocked.

#### AutoStar Polar Alignment

AutoStar provides three different (manual) methods for polar alignment: Easy, One-Star and Two-Star.

#### Easy Polar Alignment

Two alignment stars are chosen by AutoStar based on the date, time and location. First, choose "Polar" from the "Setup: Telescope: Mount" menu. The rest of the procedure is identical to the Alt/Az **AUTOMATIC ALIGNMENT**, page 17.

#### One-Star Polar Alignment

Polar One-Star Alignment requires some knowledge of the night sky. AutoStar provides a database of bright stars and one star from this database is chosen by the observer for alignment. Polaris is chosen by AutoStar. First, choose "Polar" from the "Setup: Telescope: Mount" menu. The rest of the procedure is almost identical to the Alt/Az **ONE STAR ALT/AZ ALIGNMENT**, page 36, except that AutoStar prompts you to point the telescope at Polaris and center it in the telescope eyepiece.

#### Two-Star Polar Alignment

Polar Two-Star Alignment requires some knowledge of the night sky. AutoStar provides a database of bright stars and two stars from this database are chosen by the observer for alignment. First, choose "Polar" from the "Setup: Telescope: Mount" menu. The rest of the procedure is almost identical to the Alt/Az **TWO STAR ALT/AZ ALIGNMENT**, page 36.

#### Locating the Celestial Pole

To get basic bearings at an observing location, take note of where the Sun rises (East) and sets (West) each day. After the site is dark, face North by pointing your left shoulder toward where the Sun sets. To precisely point at the pole, find the North Star (Polaris) by using the Big Dipper as a guide (**Fig. 50, next page**).

**Important Note:** For almost all astronomical observing requirements, approximate settings of the telescope's latitude and Polar axis are acceptable. Do not allow undue attention to precise Polar Alignment of the telescope to interfere with your basic enjoyment of the instrument.

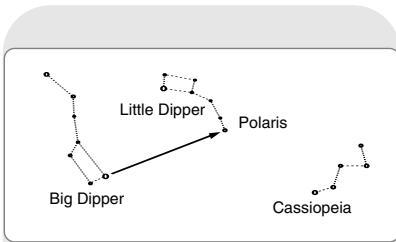

**Fig. 50:** Locating Polaris

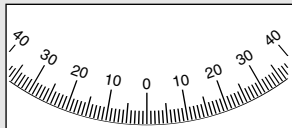

**Fig. 51:** Section of Declination setting circle.

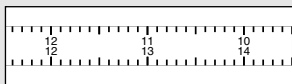

**Fig. 52:** Section of Right Ascension setting circle.

### Setting Circles

The ETX models are equipped with R.A. and Dec. setting circles (**13 and 16, Fig. 1a**) to aid in locating faint celestial objects *when the telescope has been polar aligned*. Setting circles emulate the celestial coordinates found on star charts or in sky catalogs. Any charted object is easily located by coordinates in R.A. (in hours, minutes and seconds, from 0h 0m 0s to 23h 59m 59s) and Dec. (in degrees from 0° to ±90°).

With an ETX model polar aligned, use the Arrow keys to move the telescope in R.A. (left and right keys) and Dec. (up and down keys).

**Note:** *The Dec. setting circle is located on the left arm of the telescope fork mount. The right arm of the mount contains a graduated circle (mounted behind the knurled knob of the vertical lock), without Dec. numbers.*

- **Declination Setting Circle:** The Dec. setting circle (**Fig. 51**) has been factory set to read the correct Declination of celestial objects.

Because the smooth knob on this fork mount arm need never be loosened, the Dec. setting circle should always remain calibrated. If for some reason this knob becomes loose and the Dec. setting circle must be recalibrated, level the optical tube (**5, Fig. 1a**) so that it is parallel to the drive base. Loosen the smooth knob covering the Dec. setting circle until the setting circle moves freely. Reposition the setting circle so that the 0 setting aligns with the Dec. pointer (the molded triangle beneath the setting circle). Retighten the Dec. knob.

- **Right Ascension Setting Circle:** Since celestial objects move in R.A., the R.A. setting circle (**Fig. 52**) must be reset as each object is located during an observing session. The R.A. pointer is located on the drive base 90° *counterclockwise* from the telescope's Computer Control panel (**10, Fig. 1a**) immediately under the R.A. circle.

To use the setting circles to find astronomical objects, the ETX must first be polar aligned. It is advisable that the motor drive be turned on and that a low-power eyepiece (*e.g.*, a 26mm eyepiece) be employed. Then use the following procedure:

1. Identify the celestial coordinates (R.A. and Dec.) of a bright, easy-to-find object, such as a bright star. (Avoid using Polaris or any object near Polaris.) Coordinates of bright stars are listed in astronomy magazines, text books or star charts. Center this object in the telescope's field of view.
2. Manually turn the R.A. circle (**13, Fig. 1a**) to read the R.A. of the object at the R.A. pointer (the molded triangle beneath this setting circle).
3. The R.A. circle is now calibrated to read the correct R.A. of any object at which the telescope is pointed. The Dec. circle is already calibrated through polar alignment.
4. To find another object, again identify the R.A. and Dec. coordinates. Then, *without touching the setting circles*, move the telescope (manually, by unlocking the vertical and horizontal locks or by slewing the telescope using the Arrow keys) so that the R.A. and Dec. pointers read the coordinates of the second object.
5. If the above procedure has been followed carefully, the second object will now be in the telescope's field of view.

**Note:** *Since the second object (i.e., the object to be located) is in constant motion, once the R.A. circle is calibrated (step 2, above) the telescope should be moved rapidly to read the coordinates of the second object. Otherwise the second object will no longer be in the position indicated by the R.A. circle.*

Using setting circles requires a developed technique. When using the circles for the first time, try hopping from one bright star (the calibration star) to another bright star of known coordinates. Practice moving the telescope from one easy-to-find object to another. In this way the precision required for accurate object location becomes familiar.

# APPENDIX B: LATITUDE CHART

## Latitude Chart for Major Cities of the World

To aid in the polar alignment procedure (see page 51), latitudes of major cities around the world are listed below. To determine the latitude of an observing site not listed on the chart, locate the city closest to your site. Then follow the procedure below:

**Northern hemisphere observers (N):** If the site is over 70 miles (110 km) North of the listed city, add one degree for every 70 miles. If the site is over 70 miles South of the listed city, subtract one degree per 70 miles.

**Southern Hemisphere observers (S):** If the site is over 70 miles (110 km) North of the listed city, subtract one degree for every 70 miles. If the site is over 70 miles South of the listed city, add one degree per 70 miles.

NORTH AMERICA			SOUTH AMERICA		
City	State/Prov./Country	Latitude	City	Country	Latitude
Albuquerque	New Mexico	35° N	Bogotá	Colombia	4° N
Anchorage	Alaska	61° N	São Paulo	Brazil	23° S
Atlanta	Georgia	34° N	Buenos Aires	Argentina	35° S
Boston	Massachusetts	42° N	Montevideo	Uruguay	35° S
Calgary	Alberta	51° N	Santiago	Chile	34° S
Chicago	Illinois	42° N	Caracas	Venezuela	10° N
Cleveland	Ohio	41° N			
Dallas	Texas	33° N	ASIA		
Denver	Colorado	40° N	City	Country	Latitude
Detroit	Michigan	42° N	Beijing	China	40° N
Honolulu	Hawaii	21° N	Hong Kong	China	23° N
Jackson	Mississippi	32° N	Seoul	South Korea	37° N
Kansas City	Missouri	39° N	Taipei	Taiwan	25° N
Kenosha	Wisconsin	45° N	Tokyo	Japan	36° N
Las Vegas	Nevada	36° N	Sapporo	Japan	43° N
Little Rock	Arkansas	35° N	Bombay	India	19° N
Los Angeles	California	34° N	Calcutta	India	22° N
Mexico City	Mexico	19° N	Hanoi	Vietnam	21° N
Miami	Florida	26° N	Jedda	Saudi Arabia	21° N
Minneapolis	Minnesota	45° N			
Nashville	Tennessee	36° N	AFRICA		
New Orleans	Louisiana	30° N	City	Country	Latitude
New York	New York	41° N	Cairo	Egypt	30° N
Oklahoma City	Oklahoma	35° N	Cape Town	South Africa	34° S
Ottawa	Ontario	45° N	Rabat	Morocco	34° N
Philadelphia	Pennsylvania	40° N	Tunis	Tunisia	37° N
Phoenix	Arizona	33° N	Windhoek	Namibia	23° S
Portland	Oregon	46° N			
Salt Lake City	Utah	41° N	AUSTRALIA AND OCEANIA		
San Antonio	Texas	29° N	City	State/Country	Latitude
San Diego	California	33° N	Adelaide	South Australia	35° S
San Francisco	California	38° N	Brisbane	Queensland	27° S
Seattle	Washington	47° N	Canberra	New South Wales	35° S
Washington	District of Columbia	39° N	Alice Springs	Northern Territory	24° S
			Hobart	Tasmania	43° S
			Perth	Western Australia	32° S
			Sydney	New South Wales	34° S
			Melbourne	Victoria	38° S
			Auckland	New Zealand	37° S
EUROPE					
City	Country	Latitude			
Amsterdam	Netherlands	52° N			
Athens	Greece	38° N			
Bern	Switzerland	47° N			
Copenhagen	Denmark	56° N			
Dublin	Ireland	53° N			
Frankfurt	Germany	50° N			
Glasgow	Scotland	56° N			
Helsinki	Finland	60° N			
Lisbon	Portugal	39° N			
London	England	51° N			
Madrid	Spain	40° N			
Oslo	Norway	60° N			
Paris	France	49° N			
Rome	Italy	42° N			
Stockholm	Sweden	59° N			
Vienna	Austria	48° N			
Warsaw	Poland	52° N			

# APPENDIX C: TRAINING THE DRIVE

Train the telescope motors using AutoStar. Perform this procedure if you are experiencing any pointing accuracy problems. **Fig. 53** depicts the complete Drive Training procedure.

**Note:** Use a terrestrial object, such as a telephone pole or lamp post, to train the drive. Complete this exercise once every 3 to 6 months to maintain the highest level of telescope pointing accuracy.

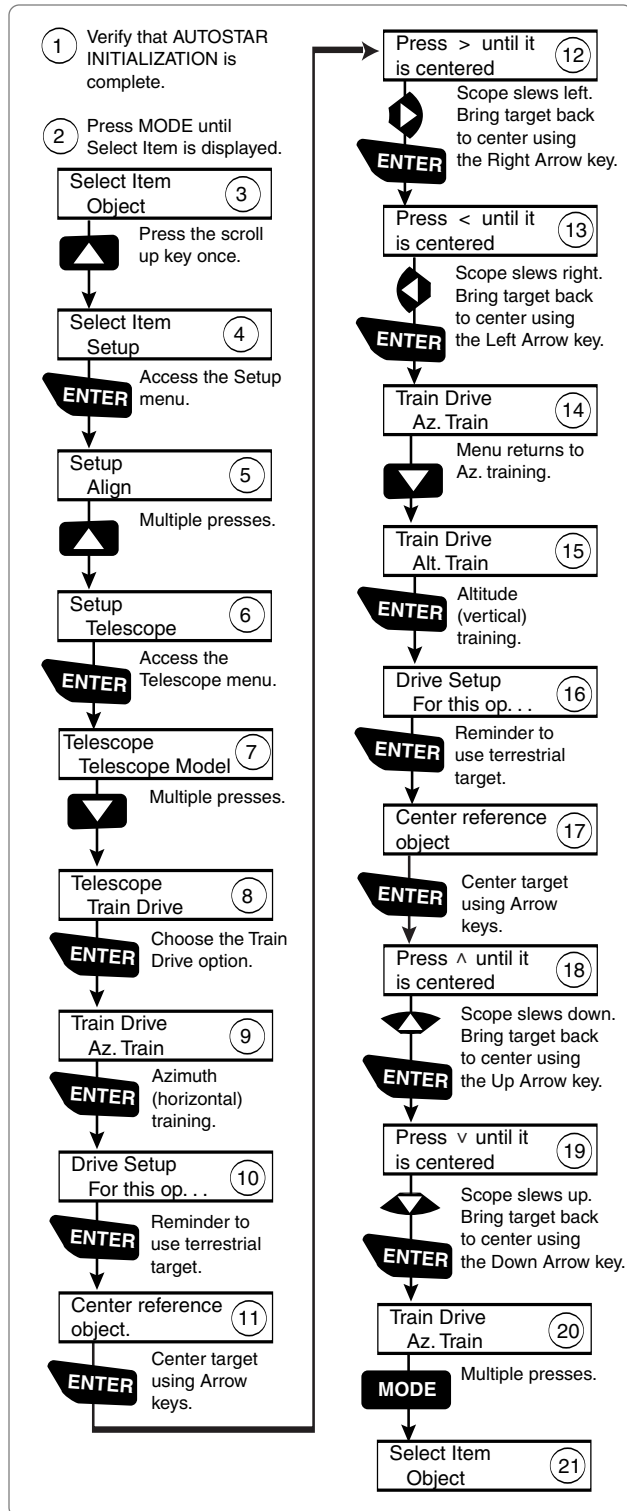

Fig. 53: Training the Drive Procedure.

## ETX TIPS

### Further Study...

This manual gives only the briefest introduction to astronomy. If you are interested in pursuing further studies in astronomy, a few topics are suggested below that are worth reading up on (some of the topics are easy and some are quite challenging). Try looking up some of these in the AutoStar glossary.

Also included below is a small sampling of books, magazines and organizations that you might find helpful.

#### Topics

1. How is a star born? How does a solar system form?
2. How is the distance to a star measured? What is a light year? What is red shift and blue shift?
3. How are the craters on our Moon formed? Is there water under the surface of the Moon?
4. What is a black hole? A neutron star? A quark star? A gamma burster? An Einstein lens?
5. What are stars made of? Why are stars different colors? How is the elemental composition of a star determined? What is an Lyman Alpha forest?
6. What is the difference between a Type 1 and a Type II supernova?
7. What is the importance of studying the composition of comets? Where do comets come from?
8. How old is our Sun? Will our Sun evolve into a planetary nebula or go supernova?
9. What is the Inflationary Big Bang? What is dark matter? What are MACHO's?
10. How are extrasolar planets discovered? What is an accretion (or protoplanetary) disk?
11. What are the differences between elliptical, spiral and irregular galaxies? Can globular clusters be older than the universe itself?

#### Books

1. *The Guide to Amateur Astronomy* by Jack Newton and Philip Teece
2. *The Sky: A User's Guide* by David Levy
3. *Turn Left at Orion* by Guy Consolmagno & Dan Davis
4. *Astrophotography for the Amateur* by Michael Covington

#### Magazines

1. *Sky & Telescope*  
Box 9111, Belmont, MA 02178
2. *Astronomy*  
Box 1612, Waukesha, WI 53187

#### Organizations:

1. Astronomical League  
Executive Secretary  
5675 Real del Norte, Las Cruces, NM 88012
2. The Astronomical Society of the Pacific  
390 Ashton Ave., San Francisco, CA 94112
3. The Planetary Society  
65 North Catalina Ave, Pasadena, CA 91106

And watch Jack Horkheimer, *Star Gazer*, on your local PBS station. Visit Jack's website at: [www.jackstargazer.com](http://www.jackstargazer.com)



## APPENDIX D: CHANGING THE LNT MODULE BATTERY

The LNT Module uses a lithium coin CR2023 battery that will last about 5 years and is installed with the original LNT Module assembly. After you replace the battery, you will need to recalibrate the telescope's sensors and reset the time and date. You will need a new battery. Also, you may use Meade's optional Atomic Time Update Module, although this is not necessary.

### To replace the battery:

1. Remove the top alignment screw cap/long bolt from the LNT Module. See **Fig. 54**.
  2. Remove the side alignment screw cap/long bolt from the LNT Module. Take note that there are two springs inside the LNT. One spring sits between the top and bottom of the unit. The second spring is on the side of the unit that rests between the bottom and the top sections. One long bolt passes through the top spring and the other long bolt passes through the side spring. Set the springs aside as you will need to replace it later in this assembly. See **Fig. 55 and 56**.
- Important Note:** Note there is some wiring inside the LNT Module. Be careful not to pull on the wiring. If it is necessary to move the wiring aside, do so carefully.
3. Carefully lift the top section of the unit from the bottom section. Do not remove the bottom section or disassemble the rest of the unit.
  4. Remove the old battery. Note the spring.
  5. Insert the new (user-supplied) battery. Take care to orient the battery so that the side with the battery markings is facing the top.
  6. Replace the top spring in place and the LNT Module cover.
  7. Replace the top bolt and tighten the cap to a firm feel.
  8. Hold the side spring in place with your fingers and slide the spring between the top and bottom sections. The spring should line up with the mounting holes for the side long bolt. Slide the long bolt through the side hole, then through the spring and finally through the bottom of the LNT Module and tighten to a firm feel.
  9. Next you will need to recalibrate the LNT Module sensors. Select Calibrate Sensors from the Setup: Telescope menu. A scrolling message displays.
  10. The message prompts you to place the telescope in the home position:
    - Loosen the telescope's vertical lock (**6, Fig. 1B**). This will allow you to move the telescope's optical tube up and down.
    - Level the tripod head. See **Step #3g**, page 12. Level the optical tube by lining up 0° on the Dec setting circle (**16, Fig. 1a**) with the Dec pointer (the small molded triangle under the setting circle).
    - Retighten the vertical lock (**6, Fig. 1b**) to a firm feel only.
    - Unlock the horizontal lock (**9, Fig. 1a**). This will allow you to rotate the telescope tube and fork arm assembly.
    - Grasp the telescope by a fork arm and rotate the telescope counterclockwise until it stops.
    - Re-lock the Horizontal lock (**9, Fig. 1**).
  11. Press ENTER. The telescope will automatically find North, detect level and the tilt of you telescope, and calibrate the sensors.
  12. Next, follow the instructions included with the Atomic Time Update Module optional accessory to reset the clock.

OR

Enter the date and time manually using the Date and Time options in the Setup menu.

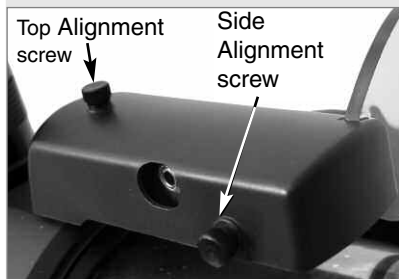

Fig. 54: The LNT Module, with alignment screws and Atomic Time Update port visible.

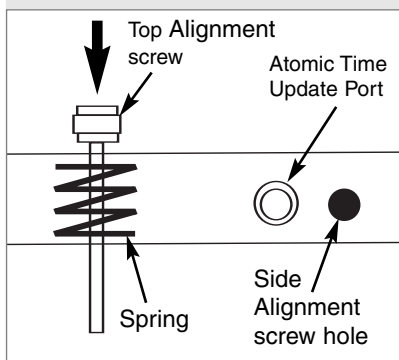

Fig. 55: Interior side view of LNT Module.

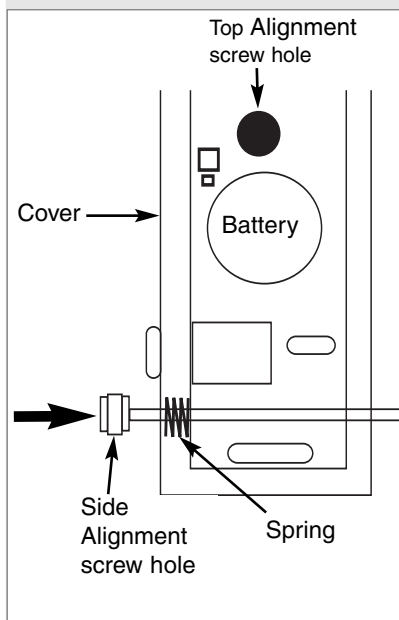

Fig. 56 Interior top view of SmartFinder unit.



# APPENDIX E: BASIC ASTRONOMY

In the early 17th century Italian Scientist Galileo, using a telescope smaller than your ETX, turned it skyward instead of looking at the distant trees and mountains. What he saw and what he realized about what he saw, has forever changed the way mankind thinks about the universe. Imagine what it must have been like being the first human to see moons revolve around the planet Jupiter or to see the changing phases of Venus! Because of his observations, Galileo correctly realized Earth's movement and position around the Sun and in doing so, gave birth to modern astronomy. Yet Galileo's telescope was so crude, he could not clearly make out the rings of Saturn.

Galileo's discoveries laid the foundation for understanding the motion and nature of the planets, stars and galaxies. Building on his foundation, Henrietta Leavitt determined how to measure the distance to stars, Edwin Hubble gave us a glimpse into the possible origin of the universe, Albert Einstein unraveled the crucial relationship of time and light and 21st-century astronomers are currently discovering planets around stars outside our solar system. Almost daily, using sophisticated successors to Galileo's telescope, such as the Hubble Space Telescope and the Chandra X-Ray Telescope, more and more mysteries of the universe are being probed and understood. We are living in the golden age of astronomy.

Unlike other sciences, astronomy welcomes contributions from amateurs. Much of the knowledge we have on subjects such as comets, meteor showers, double and variable stars, the Moon and our solar system comes from observations made by amateur astronomers. So as you look through your Meade ETX telescope, keep in mind Galileo. To him, a telescope was not merely a machine made of glass and metal, but something far more—a window of incredible discovery.



Fig. 57: The Moon. Note the deep shadows in the craters.

## AutoStar Glossary

Be sure to make use of AutoStar's Glossary feature. The Glossary menu provides an alphabetical listing of definitions and descriptions of common astronomical terms. Access directly through the Glossary menu or through hypertext words embedded in AutoStar. See **GLOSSARY MENU**, page 24, for more information.

## The Moon

The Moon is, on average, a distance of 239,000 miles (380,000km) from Earth and is best observed during its crescent or half phase when Sunlight strikes the Moon's surface at an angle. It casts shadows and adds a sense of depth to the view (**Fig. 57**). No shadows are seen during a full Moon, causing the overly bright Moon to appear flat and rather uninteresting through the telescope. Be sure to use a neutral Moon filter when observing the Moon. Not only does it protect your eyes from the bright glare of the Moon, but it also helps enhance contrast, providing a more dramatic image.

Using your ETX model, brilliant detail can be observed on the Moon, including hundreds of lunar craters and maria, described below.

**Craters** are round meteor impact sites covering most of the Moon's surface. With no atmosphere on the Moon, no weather conditions exist, so the only erosive force is meteor strikes. Under these conditions, lunar craters can last for millions of years.

**Maria (plural for *mare*, seas)** are smooth, dark areas scattered across the lunar surface. These areas are ancient impact basins that were filled with lava from the interior of the Moon by the depth and force of the meteor or comet impact.

**12 Apollo astronauts** left their bootprints on the Moon in the late 1960's and early 1970's. However, no telescope on Earth can see these footprints or any other artifacts. In fact, the smallest lunar features that may be seen with the largest telescope on Earth are about one-half mile across.

**Note:** Except during its early or late crescent phases, the Moon can be an exceptionally bright object to view through the telescope. To reduce the brightness and glare, use the #905 Variable Polarizing Filter (see the **MEADE GENERAL CATALOG** for more information).

**Tip:**

Enter a date in the Date menu and you can determine if a planet(s)—or any other object in the database—will be visible during the night of the entered date.

After entering a new date, go to the Object menu and select the desired planet from the menu. Then keep pressing one of the Scroll keys until the rise and set times display. Press MODE to exit.

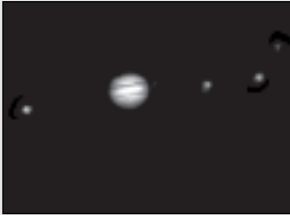

*Fig. 58: The planet Jupiter. Jupiter's four largest moons can be observed in a different position every night.*

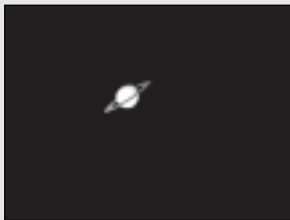

*Fig. 59: Saturn has the most extensive ring structure in our Solar System.*



*Fig. 60: The Pleiades is one of the most beautiful open clusters.*

## Planets

Planets change positions in the sky as they orbit around the Sun. To locate the planets on a given day or month, consult a monthly astronomy magazine, such as *Sky and Telescope* or *Astronomy*. Listed below are the best planets for viewing through your ETX model telescope.

**Venus** is about nine-tenths the diameter of Earth. As Venus orbits the Sun, observers can see it go through phases (crescent, half and full) much like those of the Moon. The disk of Venus appears white, as sunlight is reflected off the thick cloud cover that completely obscures any surface detail.

**Mars** is about half the diameter of Earth. Through the telescope it appears as a tiny reddish-orange disk. You may see a hint of white at one of the planet's polar ice caps. Approximately every two years, when Mars is closest to Earth, additional detail and coloring on the planet's surface may be visible.

**Jupiter (Fig. 58)** is the largest planet in our solar system, with a diameter 11 times that of Earth. Jupiter appears as a disk with dark lines stretching across the surface. These lines are cloud bands in the atmosphere. Four of Jupiter's 29 (and still counting!) moons (Io, Europa, Ganymede and Callisto) can be seen as star-like points of light when you use even the lowest magnification. The number of moons visible on any given night changes as they circle around the giant planet.

**Saturn (Fig. 59)** is nine times the diameter of Earth and appears as a small, round disk with rings extending out from either side. In 1610, Galileo, the first person to observe Saturn through a telescope, did not understand that what he was seeing were rings. Instead, he believed that Saturn had "ears." Saturn's rings are composed of billions of ice particles. The major division in Saturn's rings, called the Cassini Division, is generally visible through all three ETX models. Titan, the largest of Saturn's moons, can also be seen as a bright, star-like object near the planet.

## Deep-Sky Objects

You can use star charts to locate constellations, individual stars and deep-sky objects. Examples of various deep-sky objects are given below:

**Stars** are large gaseous objects that are illuminated by nuclear fusion in their core. Because of their vast distances from our solar system, all stars appear as pinpoints of light, regardless of the size of the telescope used.

**Nebulae** are vast interstellar clouds of gas and dust where stars are formed. Most impressive of these is the Great Nebula in Orion (M42), a diffuse nebula that appears as a faint wispy gray cloud. M42 is 1600 light years from Earth.

**Open Clusters** are loose groupings of young stars, all recently formed from the same diffuse nebula. The Pleiades (**Fig. 60**) is an open cluster 410 light years from Earth. Several hundred stars of the cluster are visible through your telescope.

**Constellations** are large, imaginary patterns of stars believed by ancient civilizations to be the celestial equivalent of objects, animals, people or gods. These patterns are too large to be seen through a telescope. To learn the constellations, start with an easy grouping of stars, such as the Big Dipper in Ursa Major. Then use a star chart to explore across the sky.

**Galaxies** are large assemblies of stars, nebulae and star clusters that are bound by gravity. The most common shape is spiral (such as our own Milky Way), but galaxies can also be elliptical or even irregular blobs. The Andromeda Galaxy (M31) is the closest spiral-type galaxy to our own. This galaxy appears fuzzy and cigar-shaped. It is 2.2 million light years away in the constellation Andromeda.





## MEADE LIMITED WARRANTY

Every Meade telescope, spotting scope and telescope accessory is warranted by Meade Instruments Corporation ("Meade") to be free of defects in materials and workmanship for a period of ONE YEAR from the date of original purchase in the U.S.A. and Canada. Meade will repair or replace a product or part thereof, found by Meade to be defective, provided the defective part is returned to Meade, freight-prepaid, with proof of purchase. This warranty applies to the original purchaser only and is non-transferable. Meade products purchased outside North America are not included in this warranty, but are covered under separate warranties issued by Meade international distributors.

**RGA Number Required:** Prior to the return of any product or part, a Return Goods Authorization (RGA) number **must** be obtained from Meade by writing or calling (949) 451-1450. Each returned part or product must include a written statement detailing the nature of the claimed defect, as well as the owner's name, address and phone number.

This warranty is not valid in cases where the product has been abused or mishandled, where unauthorized repairs have been attempted or performed or where depreciation of the product is due to normal wear-and-tear. Meade specifically disclaims special, indirect or consequential damages or lost profit which may result from a breach of this warranty. Any implied warranties which cannot be disclaimed are hereby limited to a term of one year from the date of original retail purchase.

This warranty gives you specific rights. You may have other rights which vary from state to state.

Meade reserves the right to change product specifications or to discontinue products without notice.



**MEADE**<sup>®</sup>

6001 Oak Canyon, Irvine, California 92618

■ (949) 451-1450 ■ [www.meade.com](http://www.meade.com)

© 2004

14-1010-29 10/04